

# STARPOWER

SEMICONDUCTOR

IGBT

## GD50PIT120C6S\_T4

1200V/50A PIM in one-package

### General Description

STARPOWER IGBT Power Module provides ultra low conduction loss as well as short circuit ruggedness. They are designed for the applications such as general inverters and UPS.

### Features

- Low  $V_{CE(sat)}$  Trench IGBT technology
- 10 $\mu$ s short circuit capability
- $V_{CE(sat)}$  with positive temperature coefficient
- Maximum junction temperature 175°C
- Low inductance case
- Fast & soft reverse recovery anti-parallel FWD
- Isolated copper baseplate using DBC technology

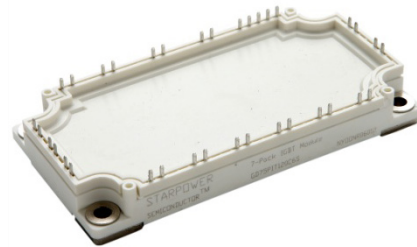

### Typical Applications

- Inverter for motor drive
- AC and DC servo drive amplifier
- Uninterruptible power supply

### Equivalent Circuit Schematic

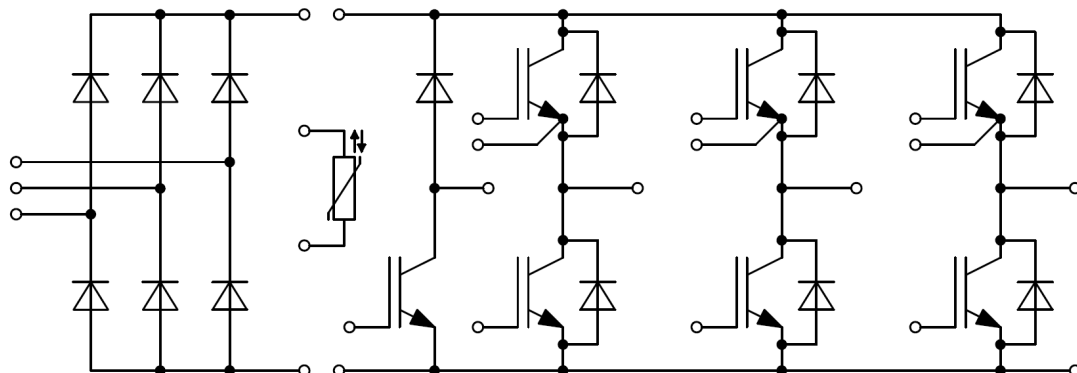

**Absolute Maximum Ratings**  $T_C=25^{\circ}\text{C}$  unless otherwise noted**IGBT-inverter**

Symbol	Description	Value	Unit
$V_{CES}$	Collector-Emitter Voltage	1200	V
$V_{GES}$	Gate-Emitter Voltage	$\pm 20$	V
$I_C$	Collector Current @ $T_C=25^{\circ}\text{C}$	80	A
	@ $T_C=100^{\circ}\text{C}$	50	
$I_{CM}$	Pulsed Collector Current $t_p=1\text{ms}$	100	A
$P_D$	Maximum Power Dissipation @ $T_j=175^{\circ}\text{C}$	321	W

**Diode-inverter**

Symbol	Description	Value	Unit
$V_{RRM}$	Repetitive Peak Reverse Voltage	1200	V
$I_F$	Diode Continuous Forward Current	50	A
$I_{FM}$	Diode Maximum Forward Current $t_p=1\text{ms}$	100	A

**Diode-rectifier**

Symbol	Description	Value	Unit
$V_{RRM}$	Repetitive Peak Reverse Voltage	1600	V
$I_O$	Average Output Current 50Hz/60Hz,sine wave	50	A
$I_{FSM}$	Surge Forward Current $V_R=0\text{V}, t_p=10\text{ms}, T_j=45^{\circ}\text{C}$	850	A
$I^2t$	$I^2t$ -value, $V_R=0\text{V}, t_p=10\text{ms}, T_j=45^{\circ}\text{C}$	3610	$\text{A}^2\text{s}$

**IGBT-brake**

Symbol	Description	Value	Unit
$V_{CES}$	Collector-Emitter Voltage	1200	V
$V_{GES}$	Gate-Emitter Voltage	$\pm 30$	V
$I_C$	Collector Current @ $T_C=25^{\circ}\text{C}$	50	A
	@ $T_C=100^{\circ}\text{C}$	25	
$I_{CM}$	Pulsed Collector Current $t_p=1\text{ms}$	50	A
$P_D$	Maximum Power Dissipation @ $T_j=175^{\circ}\text{C}$	202	W

**Diode-brake**

Symbol	Description	Value	Unit
$V_{RRM}$	Repetitive Peak Reverse Voltage	1200	V
$I_F$	Diode Continuous Forward Current	25	A
$I_{FM}$	Diode Maximum Forward Current $t_p=1\text{ms}$	50	A

**Module**

Symbol	Description	Value	Unit
$T_{jmax}$	Maximum Junction Temperature(inverter,brake)	175	$^{\circ}\text{C}$
	Maximum Junction Temperature(rectifier)	150	
$T_{jop}$	Operating Junction Temperature	-40 to +150	$^{\circ}\text{C}$
$T_{STG}$	Storage Temperature Range	-40 to +125	$^{\circ}\text{C}$
$V_{ISO}$	Isolation Voltage RMS, $f=50\text{Hz}, t=1\text{min}$	4000	V

**IGBT-inverter Characteristics**  $T_C=25^\circ\text{C}$  unless otherwise noted

Symbol	Parameter	Test Conditions	Min.	Typ.	Max.	Unit	
$V_{CE(sat)}$	Collector to Emitter Saturation Voltage	$I_C=50\text{A}, V_{GE}=15\text{V}, T_j=25^\circ\text{C}$		1.85	2.30	V	
		$I_C=50\text{A}, V_{GE}=15\text{V}, T_j=125^\circ\text{C}$		2.15			
		$I_C=50\text{A}, V_{GE}=15\text{V}, T_j=150^\circ\text{C}$		2.25			
$V_{GE(th)}$	Gate-Emitter Threshold Voltage	$I_C=1.7\text{mA}, V_{CE}=V_{GE}, T_j=25^\circ\text{C}$	5.3	5.8	6.3	V	
$I_{CES}$	Collector Cut-Off Current	$V_{CE}=V_{CES}, V_{GE}=0\text{V}, T_j=25^\circ\text{C}$			1.0	mA	
$I_{GES}$	Gate-Emitter Leakage Current	$V_{GE}=V_{GES}, V_{CE}=0\text{V}, T_j=25^\circ\text{C}$			100	nA	
$R_{Gint}$	Internal Gate Resistance			4		$\Omega$	
$C_{ies}$	Input Capacitance	$V_{CE}=25\text{V}, f=1\text{MHz}, V_{GE}=0\text{V}$		2.80		nF	
$C_{res}$	Reverse Transfer Capacitance				0.10		nF
$Q_G$	Gate Charge	$V_{GE}=-15\dots+15\text{V}$		0.38		$\mu\text{C}$	
$t_{d(on)}$	Turn-On Delay Time	$V_{CC}=600\text{V}, I_C=50\text{A}, R_G=15\Omega, V_{GE}=\pm 15\text{V}, T_j=25^\circ\text{C}$		236		ns	
$t_r$	Rise Time			60		ns	
$t_{d(off)}$	Turn-Off Delay Time			281		ns	
$t_f$	Fall Time			196		ns	
$E_{on}$	Turn-On Switching Loss			5.60		mJ	
$E_{off}$	Turn-Off Switching Loss			2.75		mJ	
$t_{d(on)}$	Turn-On Delay Time		$V_{CC}=600\text{V}, I_C=50\text{A}, R_G=15\Omega, V_{GE}=\pm 15\text{V}, T_j=125^\circ\text{C}$		243		ns
$t_r$	Rise Time				64		ns
$t_{d(off)}$	Turn-Off Delay Time			378		ns	
$t_f$	Fall Time			302		ns	
$E_{on}$	Turn-On Switching Loss			7.56		mJ	
$E_{off}$	Turn-Off Switching Loss			4.48		mJ	
$t_{d(on)}$	Turn-On Delay Time	$V_{CC}=600\text{V}, I_C=50\text{A}, R_G=15\Omega, V_{GE}=\pm 15\text{V}, T_j=150^\circ\text{C}$			247		ns
$t_r$	Rise Time				66		ns
$t_{d(off)}$	Turn-Off Delay Time			490		ns	
$t_f$	Fall Time			327		ns	
$E_{on}$	Turn-On Switching Loss			8.20		mJ	
$E_{off}$	Turn-Off Switching Loss			5.00		mJ	
$I_{SC}$	SC Data		$t_p \leq 10\mu\text{s}, V_{GE}=15\text{V}, T_j=150^\circ\text{C}, V_{CC}=900\text{V}, V_{CEM} \leq 1200\text{V}$		180		A

**Diode-inverter Characteristics**  $T_C=25^{\circ}\text{C}$  unless otherwise noted

Symbol	Parameter	Test Conditions	Min.	Typ.	Max.	Unit
$V_F$	Diode Forward Voltage	$I_C=50\text{A}, V_{GE}=0\text{V}, T_j=25^{\circ}\text{C}$		1.70	2.15	V
		$I_C=50\text{A}, V_{GE}=0\text{V}, T_j=125^{\circ}\text{C}$		1.65		
		$I_C=50\text{A}, V_{GE}=0\text{V}, T_j=150^{\circ}\text{C}$		1.65		
$Q_r$	Recovered Charge	$V_R=600\text{V}, I_F=50\text{A},$ $-di/dt=1400\text{A}/\mu\text{s}, V_{GE}=-15\text{V}$ $T_j=25^{\circ}\text{C}$		5.5		$\mu\text{C}$
$I_{RM}$	Peak Reverse Recovery Current			54		A
$E_{rec}$	Reverse Recovery Energy			1.83		mJ
$Q_r$	Recovered Charge	$V_R=600\text{V}, I_F=50\text{A},$ $-di/dt=1400\text{A}/\mu\text{s}, V_{GE}=-15\text{V}$ $T_j=125^{\circ}\text{C}$		8.8		$\mu\text{C}$
$I_{RM}$	Peak Reverse Recovery Current			61		A
$E_{rec}$	Reverse Recovery Energy			3.02		mJ
$Q_r$	Recovered Charge	$V_R=600\text{V}, I_F=50\text{A},$ $-di/dt=1400\text{A}/\mu\text{s}, V_{GE}=-15\text{V}$ $T_j=150^{\circ}\text{C}$		10.2		$\mu\text{C}$
$I_{RM}$	Peak Reverse Recovery Current			64		A
$E_{rec}$	Reverse Recovery Energy			3.82		mJ

**Diode-rectifier Characteristics**  $T_C=25^{\circ}\text{C}$  unless otherwise noted

Symbol	Parameter	Test Conditions	Min.	Typ.	Max.	Unit
$V_F$	Diode Forward Voltage	$I_C=50\text{A}, T_j=150^{\circ}\text{C}$		1.03		V
$I_R$	Reverse Current	$T_j=150^{\circ}\text{C}, V_R=1600\text{V}$			1.5	mA

**IGBT-brake Characteristics**  $T_C=25^\circ\text{C}$  unless otherwise noted

Symbol	Parameter	Test Conditions	Min.	Typ.	Max.	Unit	
$V_{CE(sat)}$	Collector to Emitter Saturation Voltage	$I_C=25\text{A}, V_{GE}=15\text{V}, T_j=25^\circ\text{C}$		1.70	2.15	V	
		$I_C=25\text{A}, V_{GE}=15\text{V}, T_j=125^\circ\text{C}$		1.95			
		$I_C=25\text{A}, V_{GE}=15\text{V}, T_j=150^\circ\text{C}$		2.00			
$V_{GE(th)}$	Gate-Emitter Threshold Voltage	$I_C=1.0\text{mA}, V_{CE}=V_{GE}, T_j=25^\circ\text{C}$	5.0	5.9	6.5	V	
$I_{CES}$	Collector Cut-Off Current	$V_{CE}=V_{CES}, V_{GE}=0\text{V}, T_j=25^\circ\text{C}$			1.0	mA	
$I_{GES}$	Gate-Emitter Leakage Current	$V_{GE}=V_{GES}, V_{CE}=0\text{V}, T_j=25^\circ\text{C}$			100	nA	
$R_{Gint}$	Internal Gate Resistance			/		$\Omega$	
$C_{ies}$	Input Capacitance	$V_{CE}=30\text{V}, f=1\text{MHz}, V_{GE}=0\text{V}$		2.40		nF	
$C_{res}$	Reverse Transfer Capacitance			0.08		nF	
$Q_G$	Gate Charge	$V_{GE}=15\text{V}$		0.16		$\mu\text{C}$	
$t_{d(on)}$	Turn-On Delay Time	$V_{CC}=600\text{V}, I_C=25\text{A}, R_G=18\Omega, V_{GE}=\pm 15\text{V}, T_j=25^\circ\text{C}$		140		ns	
$t_r$	Rise Time			26		ns	
$t_{d(off)}$	Turn-Off Delay Time			201		ns	
$t_f$	Fall Time			337		ns	
$E_{on}$	Turn-On Switching Loss			1.66		mJ	
$E_{off}$	Turn-Off Switching Loss			1.64		mJ	
$t_{d(on)}$	Turn-On Delay Time		$V_{CC}=600\text{V}, I_C=25\text{A}, R_G=18\Omega, V_{GE}=\pm 15\text{V}, T_j=125^\circ\text{C}$		143		ns
$t_r$	Rise Time				28		ns
$t_{d(off)}$	Turn-Off Delay Time			216		ns	
$t_f$	Fall Time			400		ns	
$E_{on}$	Turn-On Switching Loss			1.93		mJ	
$E_{off}$	Turn-Off Switching Loss			2.35		mJ	
$t_{d(on)}$	Turn-On Delay Time	$V_{CC}=600\text{V}, I_C=25\text{A}, R_G=18\Omega, V_{GE}=\pm 15\text{V}, T_j=150^\circ\text{C}$			145		ns
$t_r$	Rise Time				30		ns
$t_{d(off)}$	Turn-Off Delay Time			218		ns	
$t_f$	Fall Time			525		ns	
$E_{on}$	Turn-On Switching Loss			2.21		mJ	
$E_{off}$	Turn-Off Switching Loss			2.71		mJ	
$I_{SC}$	SC Data		$t_p \leq 10\mu\text{s}, V_{GE}=15\text{V}, T_j=150^\circ\text{C}, V_{CC}=900\text{V}, V_{CEM} \leq 1200\text{V}$		100		A

**Diode-brake Characteristics**  $T_C=25^\circ\text{C}$  unless otherwise noted

Symbol	Parameter	Test Conditions	Min.	Typ.	Max.	Unit
$V_F$	Diode Forward Voltage	$I_C=25\text{A}, V_{GE}=0\text{V}, T_j=25^\circ\text{C}$		2.10	2.55	V
		$I_C=25\text{A}, V_{GE}=0\text{V}, T_j=125^\circ\text{C}$		2.15		
		$I_C=25\text{A}, V_{GE}=0\text{V}, T_j=150^\circ\text{C}$		2.15		
$Q_r$	Recovered Charge	$V_R=600\text{V}, I_F=25\text{A},$ $-di/dt=900\text{A}/\mu\text{s}, V_{GE}=-15\text{V}$ $T_j=25^\circ\text{C}$		1.3		$\mu\text{C}$
$I_{RM}$	Peak Reverse Recovery Current			31		A
$E_{rec}$	Reverse Recovery Energy			0.68		mJ
$Q_r$	Recovered Charge	$V_R=600\text{V}, I_F=25\text{A},$ $-di/dt=900\text{A}/\mu\text{s}, V_{GE}=-15\text{V}$ $T_j=125^\circ\text{C}$		2.2		$\mu\text{C}$
$I_{RM}$	Peak Reverse Recovery Current			38		A
$E_{rec}$	Reverse Recovery Energy			1.46		mJ
$Q_r$	Recovered Charge	$V_R=600\text{V}, I_F=25\text{A},$ $-di/dt=900\text{A}/\mu\text{s}, V_{GE}=-15\text{V}$ $T_j=150^\circ\text{C}$		2.4		$\mu\text{C}$
$I_{RM}$	Peak Reverse Recovery Current			40		A
$E_{rec}$	Reverse Recovery Energy			1.91		mJ

**NTC Characteristics**  $T_C=25^\circ\text{C}$  unless otherwise noted

Symbol	Parameter	Test Conditions	Min.	Typ.	Max.	Unit
$R_{25}$	Rated Resistance			5.0		$\text{k}\Omega$
$\Delta R/R$	Deviation of $R_{100}$	$T_C=100^\circ\text{C}, R_{100}=493.3\Omega$	-5		5	%
$P_{25}$	Power Dissipation				20.0	mW
$B_{25/50}$	B-value	$R_2=R_{25}\exp[B_{25/50}(1/T_2-1/(298.15\text{K}))]$		3375		K

**Module Characteristics**  $T_c=25^{\circ}\text{C}$  unless otherwise noted

Symbol	Parameter	Min.	Typ.	Max.	Unit
$L_{CE}$	Stray Inductance		60		nH
$R_{CC'+EE'}$ $R_{AA'+CC'}$	Module Lead Resistance, Terminal to Chip		4.00 2.00		m $\Omega$
$R_{\theta JC}$	Junction-to-Case (per IGBT-inverter) Junction-to-Case (per Diode-inverter) Junction-to-Case (per Diode-rectifier) Junction-to-Case (per IGBT-brake-chopper) Junction-to-Case (per Diode-brake-chopper)			0.467 0.676 0.635 0.742 1.267	K/W
$R_{\theta CS}$	Case-to-Sink (per IGBT-inverter) Case-to-Sink (per Diode-inverter) Case-to-Sink (per Diode-rectifier) Case-to-Sink (per IGBT-brake-chopper) Case-to-Sink (per Diode-brake-chopper)		0.140 0.203 0.190 0.222 0.380		K/W
$R_{\theta CS}$	Case-to-Sink		0.009		K/W
M	Mounting Torque, Screw:M5	3.0		6.0	N.m
G	Weight of Module		300		g

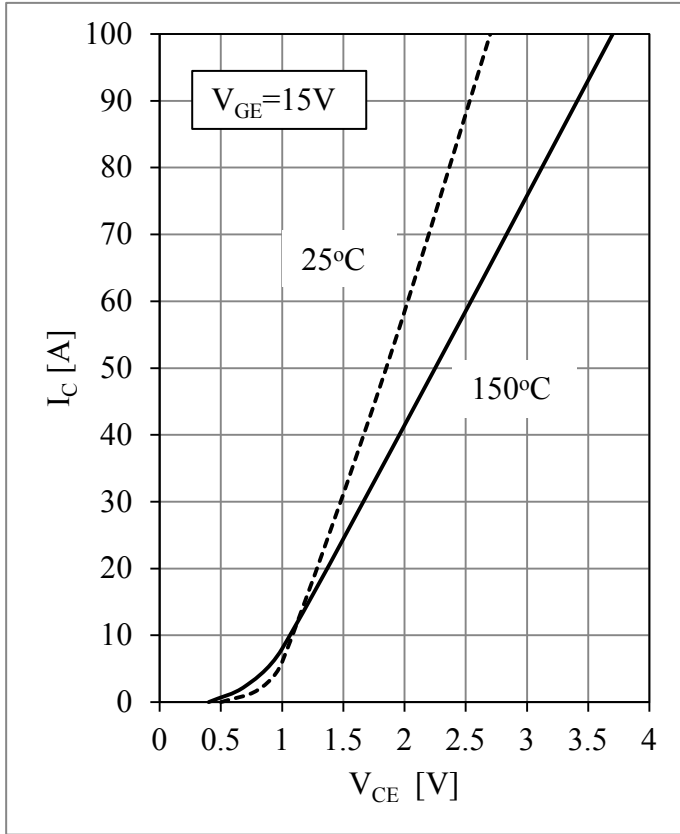

Fig 1. IGBT-inverter Output Characteristics

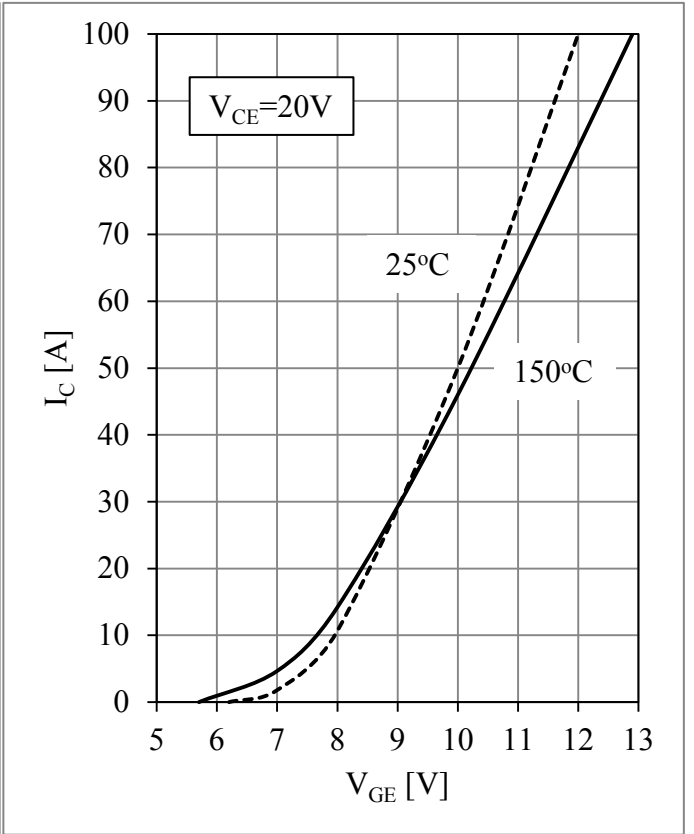

Fig 2. IGBT-inverter Transfer Characteristics

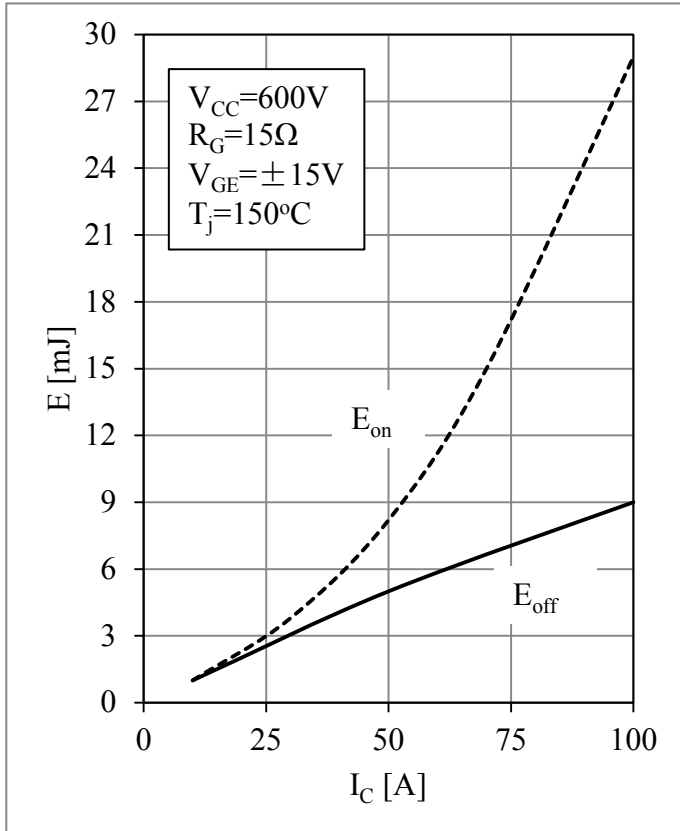

Fig 3. IGBT-inverter Switching Loss vs.  $I_C$

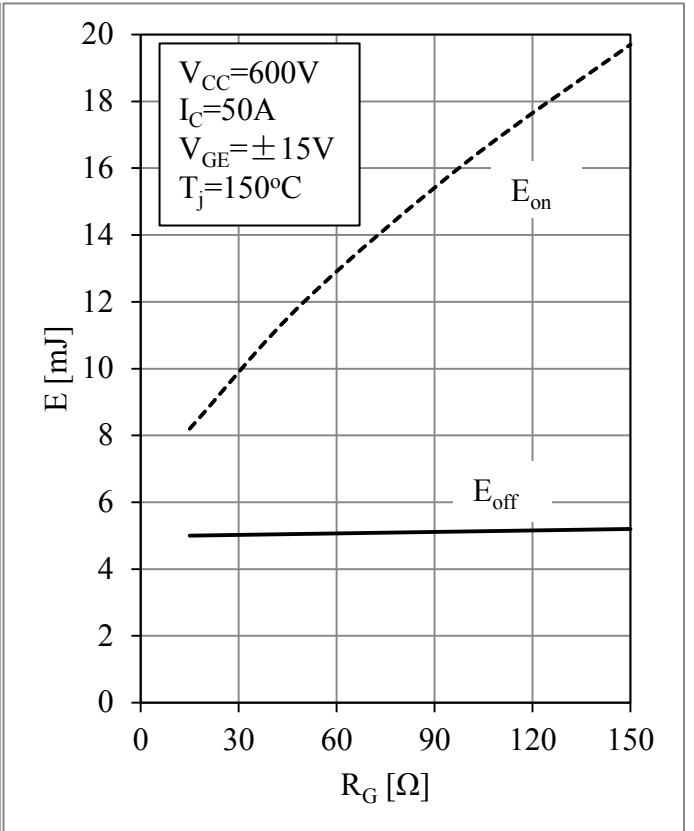

Fig 4. IGBT-inverter Switching Loss vs.  $R_G$



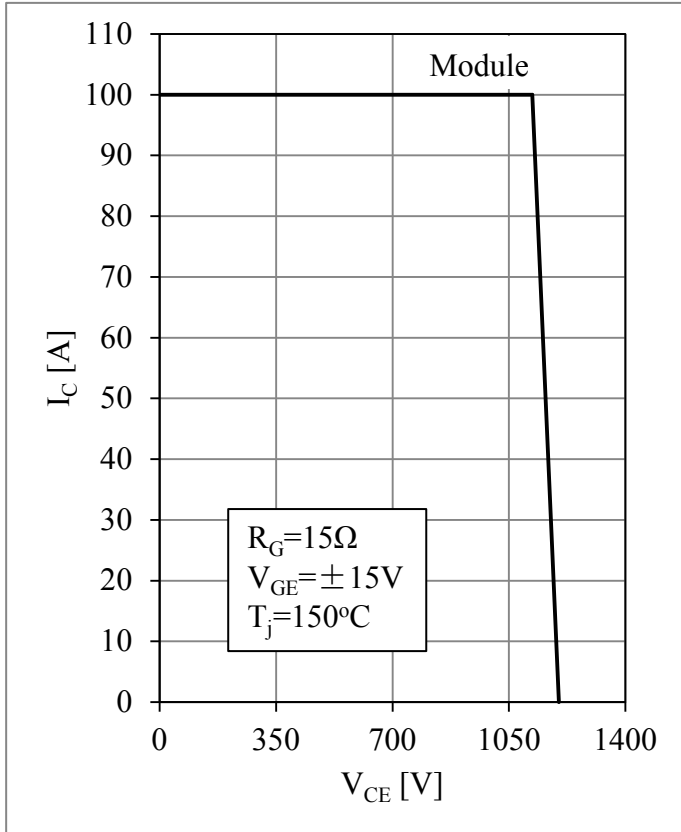

Fig 5. IGBT-inverter RBSOA

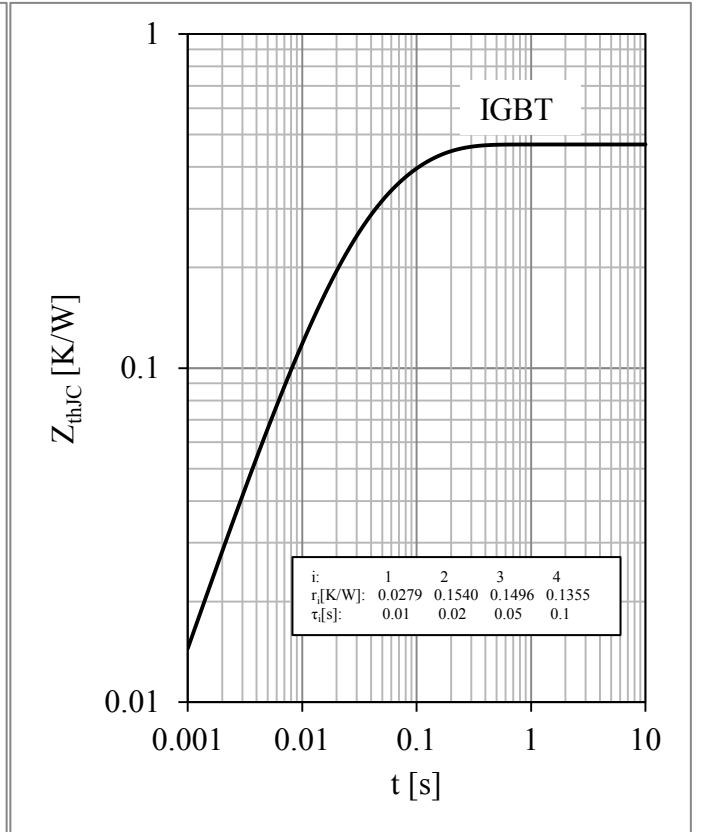

Fig 6. IGBT-inverter Transient Thermal Impedance

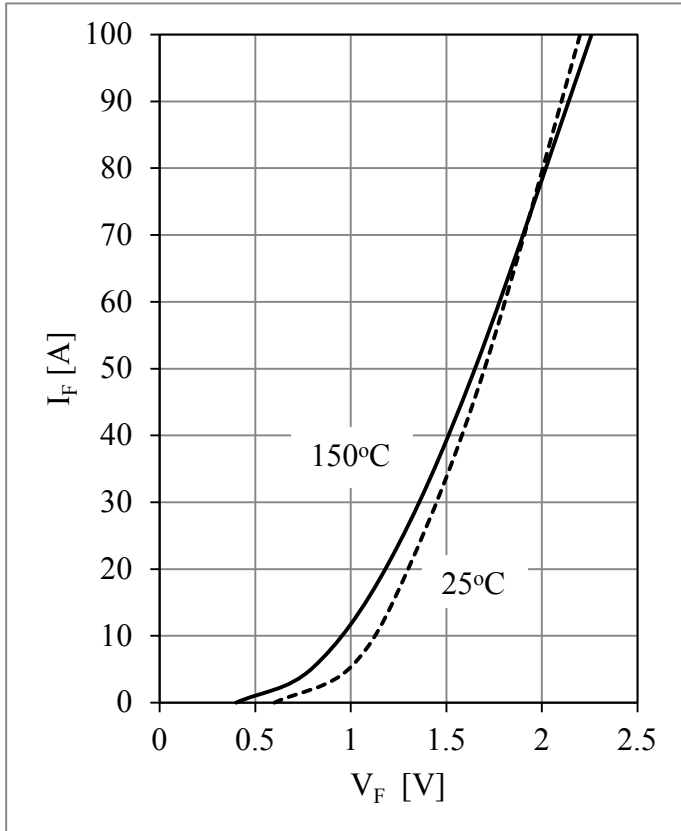

Fig 7. Diode-inverter Forward Characteristics

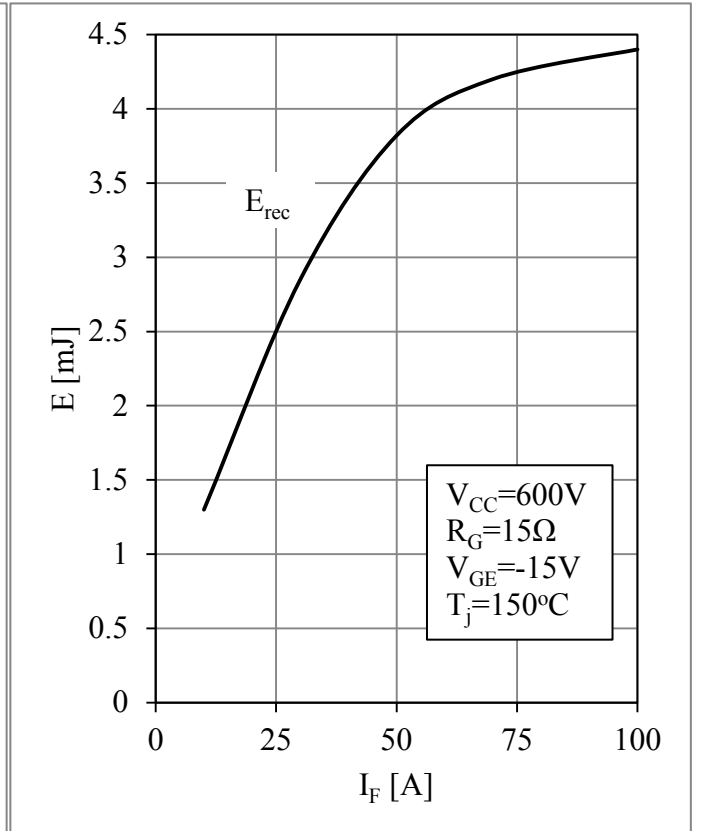

Fig 8. Diode-inverter Switching Loss vs.  $I_F$

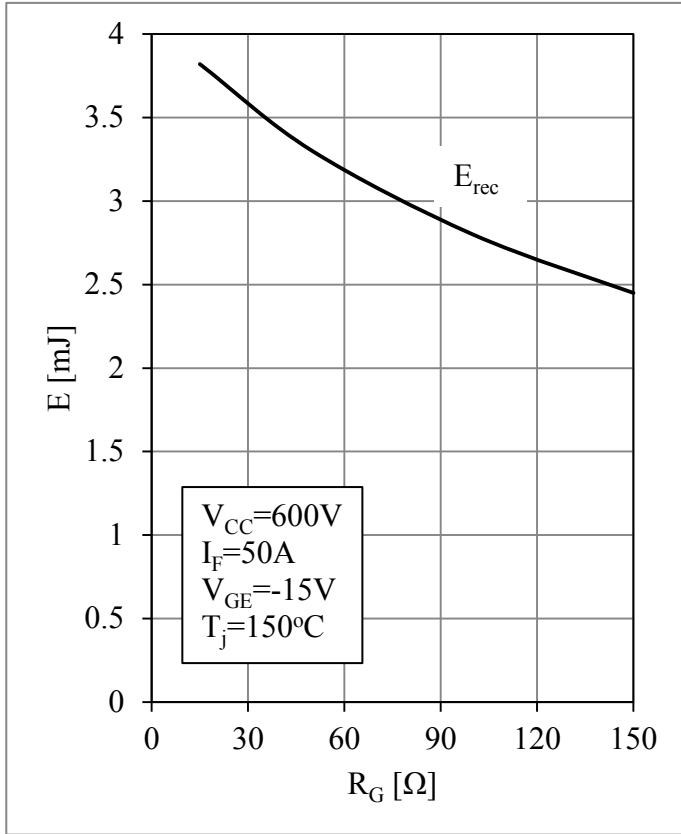

Fig 9. Diode-inverter Switching Loss vs.  $R_G$

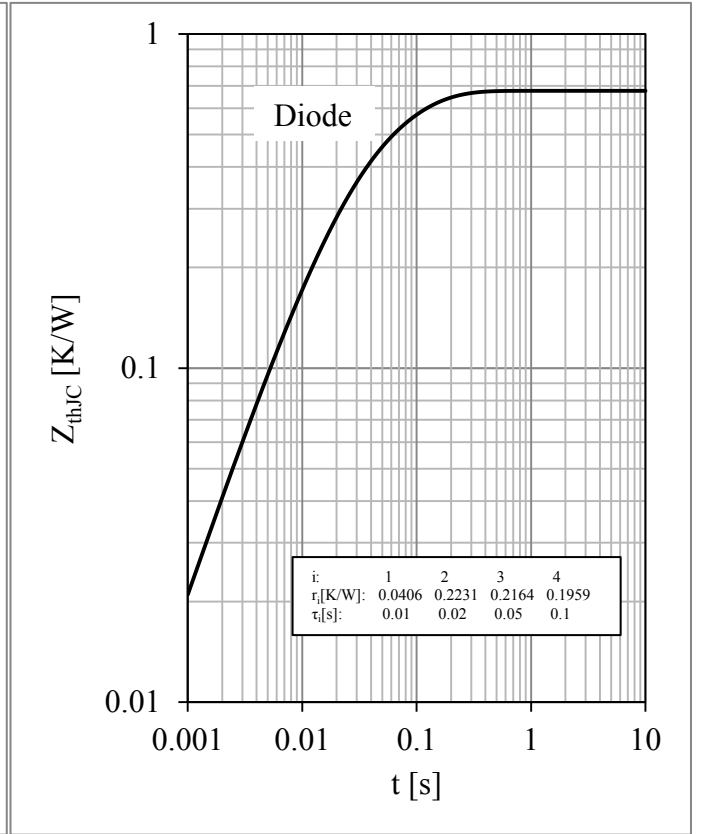

Fig 10. Diode-inverter Transient Thermal Impedance

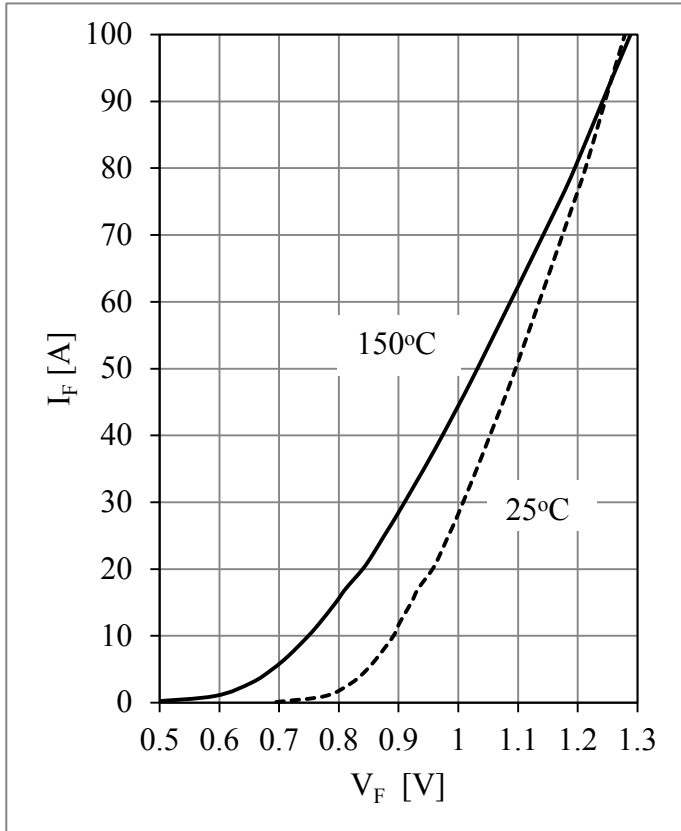

Fig 11. Diode-rectifier Forward Characteristics

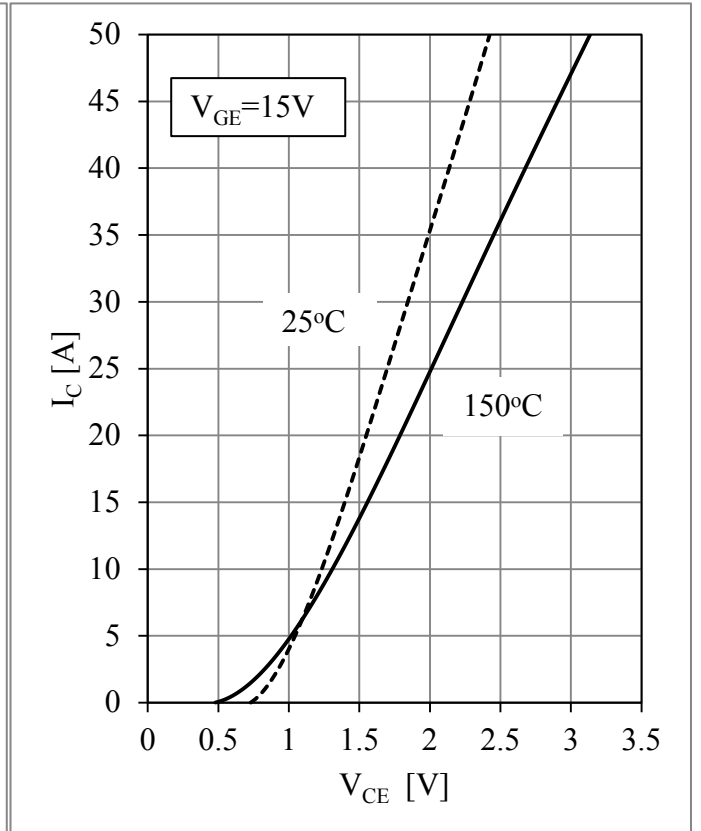

Fig 12. IGBT-brake-chopper Output Characteristics

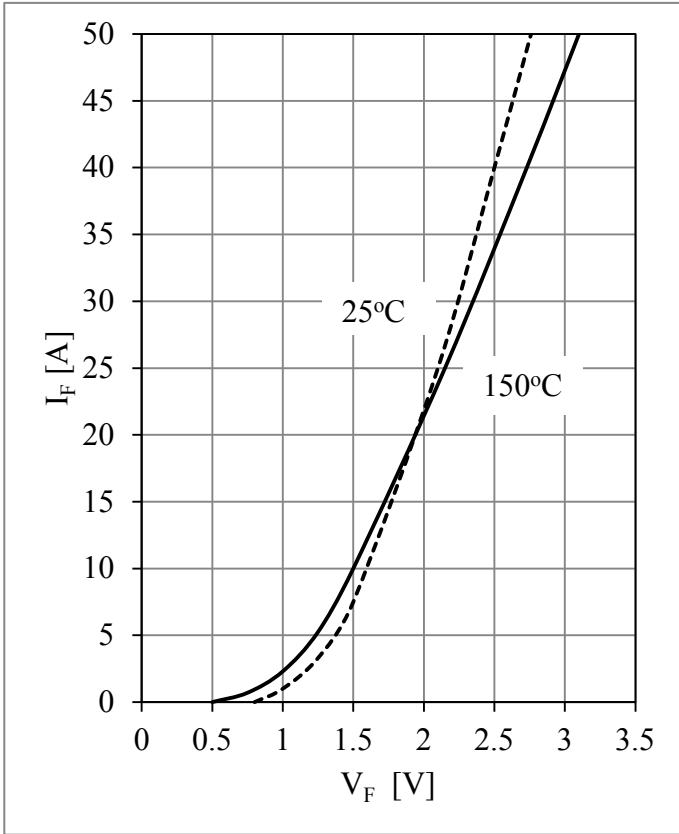

Fig 13. Diode-brake-chopper Forward Characteristics

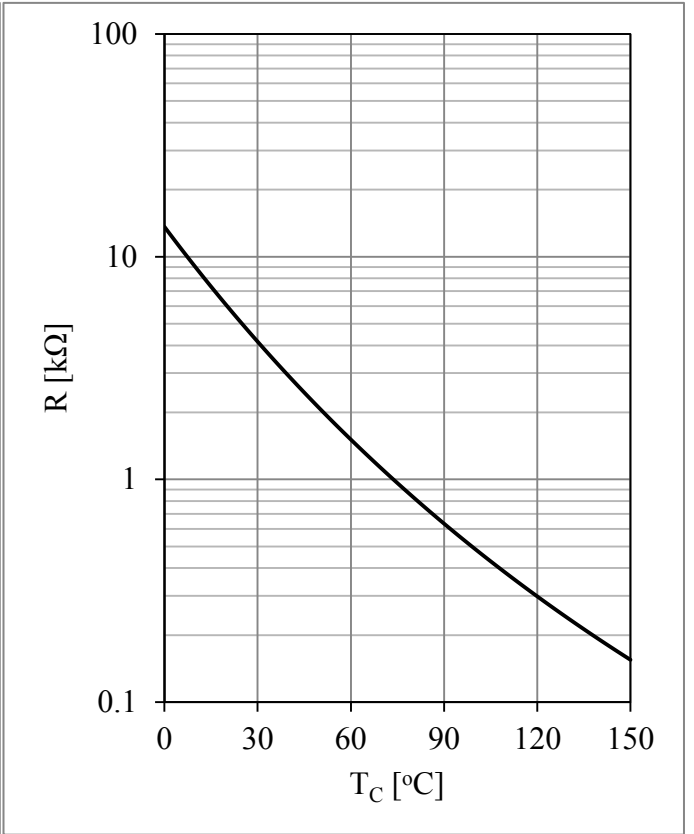
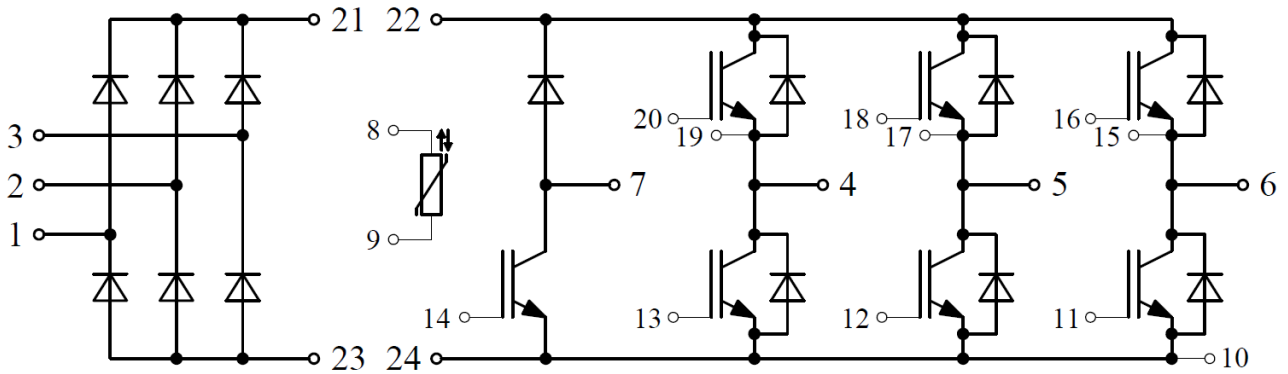

Fig 14. NTC Temperature Characteristic

**Circuit Schematic**



**Package Dimensions**

Dimensions in Millimeters

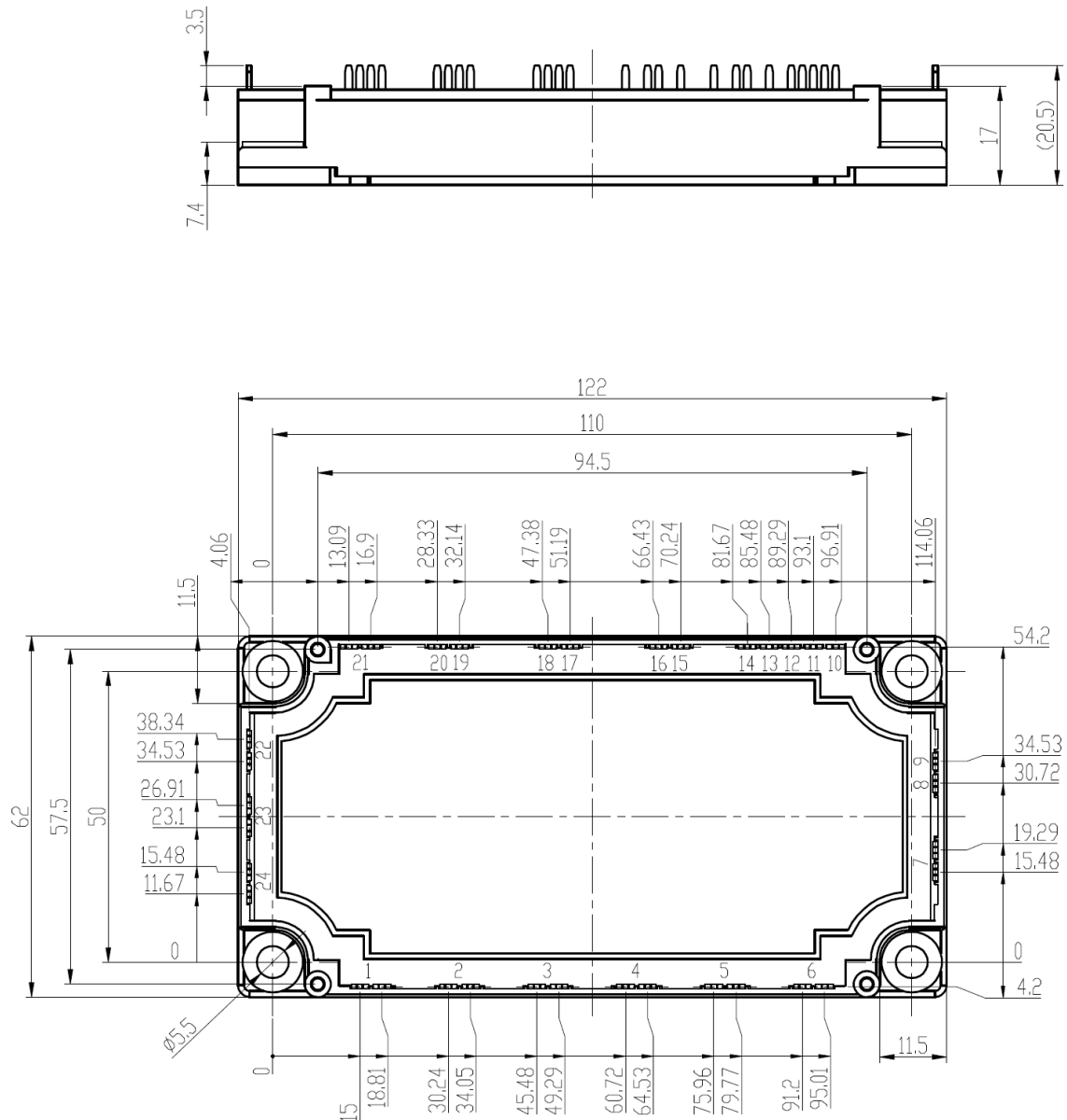

## Terms and Conditions of Usage

The data contained in this product datasheet is exclusively intended for technically trained staff. you and your technical departments will have to evaluate the suitability of the product for the intended application and the completeness of the product data with respect to such application.

This product data sheet is describing the characteristics of this product for which a warranty is granted. Any such warranty is granted exclusively pursuant the terms and conditions of the supply agreement. There will be no guarantee of any kind for the product and its characteristics.

Should you require product information in excess of the data given in this product data sheet or which concerns the specific application of our product, please contact the sales office, which is responsible for you (see [www.powersemi.cc](http://www.powersemi.cc)), For those that are specifically interested we may provide application notes.

Due to technical requirements our product may contain dangerous substances. For information on the types in question please contact the sales office, which is responsible for you.

Should you intend to use the Product in aviation applications, in health or live endangering or life support applications, please notify.

If and to the extent necessary, please forward equivalent notices to your customers.  
Changes of this product data sheet are reserved.