



**Absolute Maximum Ratings**  $T_C=25^{\circ}\text{C}$  unless otherwise noted**IGBT**

Symbol	Description	Value	Unit
$V_{CES}$	Collector-Emitter Voltage	1200	V
$V_{GES}$	Gate-Emitter Voltage	$\pm 20$	V
$I_C$	Collector Current @ $T_C=25^{\circ}\text{C}$	117	A
	@ $T_C=100^{\circ}\text{C}$	75	
$I_{CM}$	Pulsed Collector Current $t_p=1\text{ms}$	150	A
$P_D$	Maximum Power Dissipation @ $T_j=175^{\circ}\text{C}$	380	W

**Diode**

Symbol	Description	Value	Unit
$V_{RRM}$	Repetitive Peak Reverse Voltage	1200	V
$I_F$	Diode Continuous Forward Current	75	A
$I_{FM}$	Diode Maximum Forward Current $t_p=1\text{ms}$	150	A

**Module**

Symbol	Description	Value	Unit
$T_{jmax}$	Maximum Junction Temperature	175	$^{\circ}\text{C}$
$T_{jop}$	Operating Junction Temperature	-40 to +150	$^{\circ}\text{C}$
$T_{STG}$	Storage Temperature Range	-40 to +125	$^{\circ}\text{C}$
$V_{ISO}$	Isolation Voltage RMS, $f=50\text{Hz}$ , $t=1\text{min}$	4000	V

**IGBT Characteristics**  $T_C=25^\circ\text{C}$  unless otherwise noted

Symbol	Parameter	Test Conditions	Min.	Typ.	Max.	Unit	
$V_{CE(sat)}$	Collector to Emitter Saturation Voltage	$I_C=75\text{A}, V_{GE}=15\text{V}, T_j=25^\circ\text{C}$		1.70	2.15	V	
		$I_C=75\text{A}, V_{GE}=15\text{V}, T_j=125^\circ\text{C}$		1.95			
		$I_C=75\text{A}, V_{GE}=15\text{V}, T_j=150^\circ\text{C}$		2.00			
$V_{GE(th)}$	Gate-Emitter Threshold Voltage	$I_C=1.88\text{mA}, V_{CE}=V_{GE}, T_j=25^\circ\text{C}$	5.2	6.0	6.8	V	
$I_{CES}$	Collector Cut-Off Current	$V_{CE}=V_{CES}, V_{GE}=0\text{V}, T_j=25^\circ\text{C}$			1.0	mA	
$I_{GES}$	Gate-Emitter Leakage Current	$V_{GE}=V_{GES}, V_{CE}=0\text{V}, T_j=25^\circ\text{C}$			100	nA	
$R_{Gint}$	Internal Gate Resistance			5.0		$\Omega$	
$C_{ies}$	Input Capacitance	$V_{CE}=25\text{V}, f=1\text{MHz}, V_{GE}=0\text{V}$		7.76		nF	
$C_{res}$	Reverse Transfer Capacitance			0.22		nF	
$Q_G$	Gate Charge	$V_{GE}=-15\dots+15\text{V}$		0.58		$\mu\text{C}$	
$t_{d(on)}$	Turn-On Delay Time	$V_{CC}=600\text{V}, I_C=75\text{A}, R_G=2.2\Omega, V_{GE}=\pm 15\text{V}, T_j=25^\circ\text{C}$		171		ns	
$t_r$	Rise Time			32		ns	
$t_{d(off)}$	Turn-Off Delay Time			350		ns	
$t_f$	Fall Time			82		ns	
$E_{on}$	Turn-On Switching Loss			3.64		mJ	
$E_{off}$	Turn-Off Switching Loss			4.33		mJ	
$t_{d(on)}$	Turn-On Delay Time		$V_{CC}=600\text{V}, I_C=75\text{A}, R_G=2.2\Omega, V_{GE}=\pm 15\text{V}, T_j=125^\circ\text{C}$		182		ns
$t_r$	Rise Time				43		ns
$t_{d(off)}$	Turn-Off Delay Time			443		ns	
$t_f$	Fall Time			155		ns	
$E_{on}$	Turn-On Switching Loss			7.81		mJ	
$E_{off}$	Turn-Off Switching Loss			6.59		mJ	
$t_{d(on)}$	Turn-On Delay Time	$V_{CC}=600\text{V}, I_C=75\text{A}, R_G=2.2\Omega, V_{GE}=\pm 15\text{V}, T_j=150^\circ\text{C}$			182		ns
$t_r$	Rise Time				43		ns
$t_{d(off)}$	Turn-Off Delay Time			464		ns	
$t_f$	Fall Time			175		ns	
$E_{on}$	Turn-On Switching Loss			9.10		mJ	
$E_{off}$	Turn-Off Switching Loss			7.42		mJ	
$I_{SC}$	SC Data		$t_p \leq 10\mu\text{s}, V_{GE}=15\text{V}, T_j=150^\circ\text{C}, V_{CC}=900\text{V}, V_{CEM} \leq 1200\text{V}$		300		A

**Diode Characteristics**  $T_C=25^\circ\text{C}$  unless otherwise noted

Symbol	Parameter	Test Conditions	Min.	Typ.	Max.	Unit
$V_F$	Diode Forward Voltage	$I_F=75\text{A}, V_{GE}=0\text{V}, T_j=25^\circ\text{C}$		1.70	2.15	V
		$I_F=75\text{A}, V_{GE}=0\text{V}, T_j=125^\circ\text{C}$		1.65		
		$I_F=75\text{A}, V_{GE}=0\text{V}, T_j=150^\circ\text{C}$		1.65		
$Q_r$	Recovered Charge	$V_R=600\text{V}, I_F=75\text{A},$ $-di/dt=1900\text{A}/\mu\text{s}, V_{GE}=-15\text{V}$ $T_j=25^\circ\text{C}$		6.9		$\mu\text{C}$
$I_{RM}$	Peak Reverse Recovery Current			84		A
$E_{rec}$	Reverse Recovery Energy			2.47		mJ
$Q_r$	Recovered Charge	$V_R=600\text{V}, I_F=75\text{A},$ $-di/dt=1900\text{A}/\mu\text{s}, V_{GE}=-15\text{V}$ $T_j=125^\circ\text{C}$		12.4		$\mu\text{C}$
$I_{RM}$	Peak Reverse Recovery Current			85		A
$E_{rec}$	Reverse Recovery Energy			4.30		mJ
$Q_r$	Recovered Charge	$V_R=600\text{V}, I_F=75\text{A},$ $-di/dt=1900\text{A}/\mu\text{s}, V_{GE}=-15\text{V}$ $T_j=150^\circ\text{C}$		13.8		$\mu\text{C}$
$I_{RM}$	Peak Reverse Recovery Current			86		A
$E_{rec}$	Reverse Recovery Energy			5.20		mJ

**Module Characteristics**  $T_C=25^\circ\text{C}$  unless otherwise noted

Symbol	Parameter	Min.	Typ.	Max.	Unit
$L_{CE}$	Stray Inductance			30	nH
$R_{CC'+EE'}$	Module Lead Resistance, Terminal to Chip		0.75		m $\Omega$
$R_{thJC}$	Junction-to-Case (per IGBT)			0.394	K/W
	Junction-to-Case (per Diode)			0.602	
$R_{thCH}$	Case-to-Heatsink (per IGBT)		0.165		K/W
	Case-to-Heatsink (per Diode)		0.253		
	Case-to-Heatsink (per Module)		0.050		
M	Terminal Connection Torque, Screw M5	2.5		5.0	N.m
	Mounting Torque, Screw M6	3.0		5.0	
G	Weight of Module		150		g

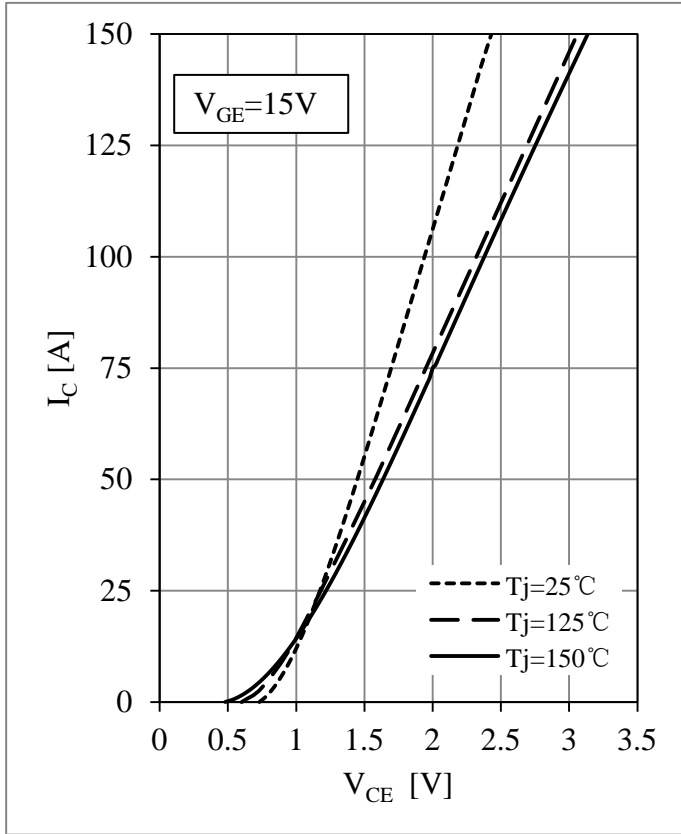

Fig 1. IGBT Output Characteristics

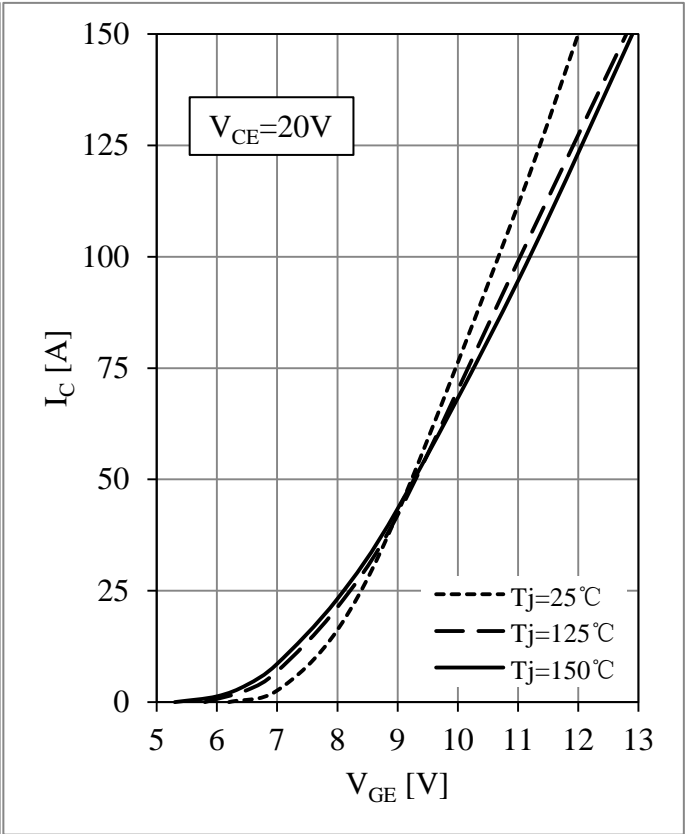

Fig 2. IGBT Transfer Characteristics

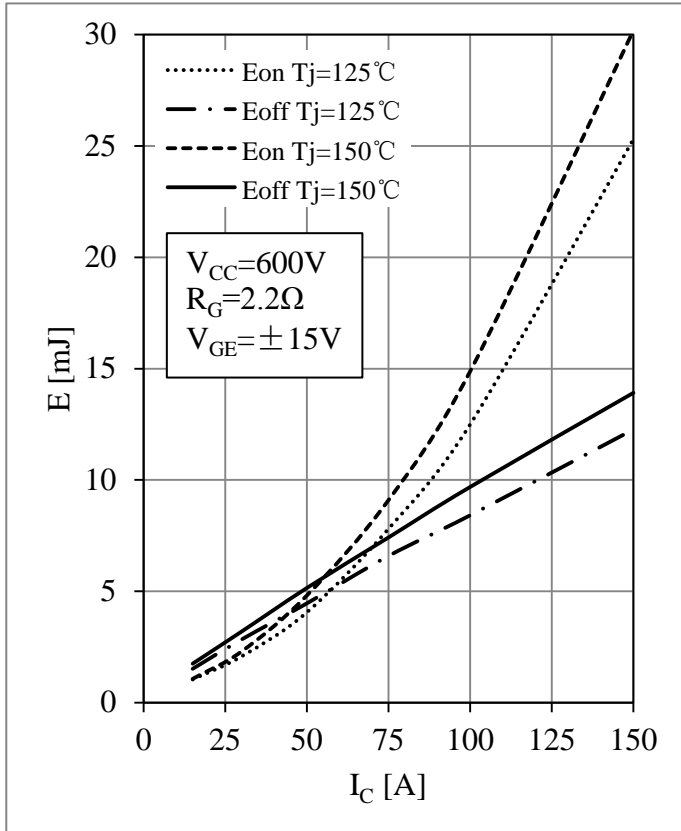

Fig 3. IGBT Switching Loss vs.  $I_C$

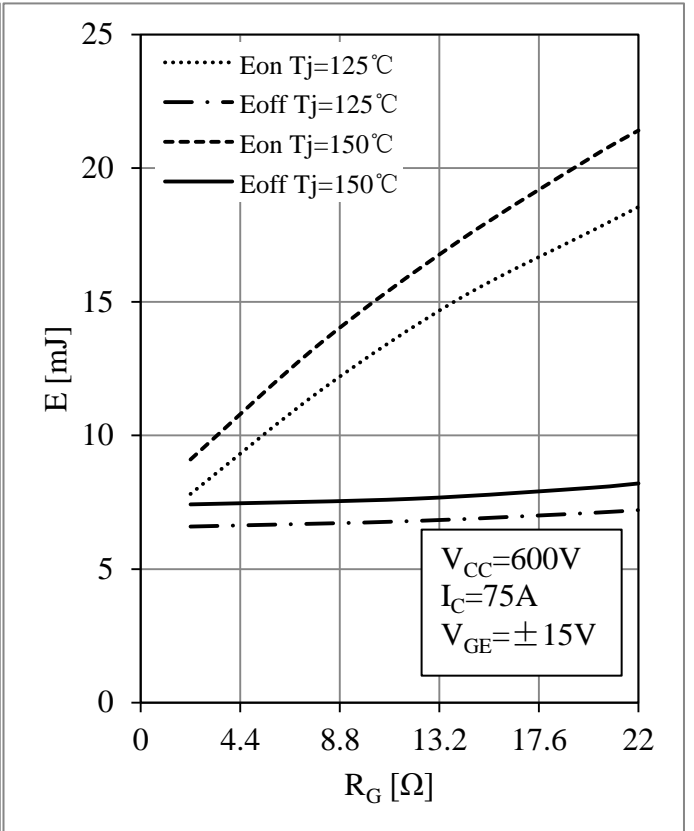

Fig 4. IGBT Switching Loss vs.  $R_G$

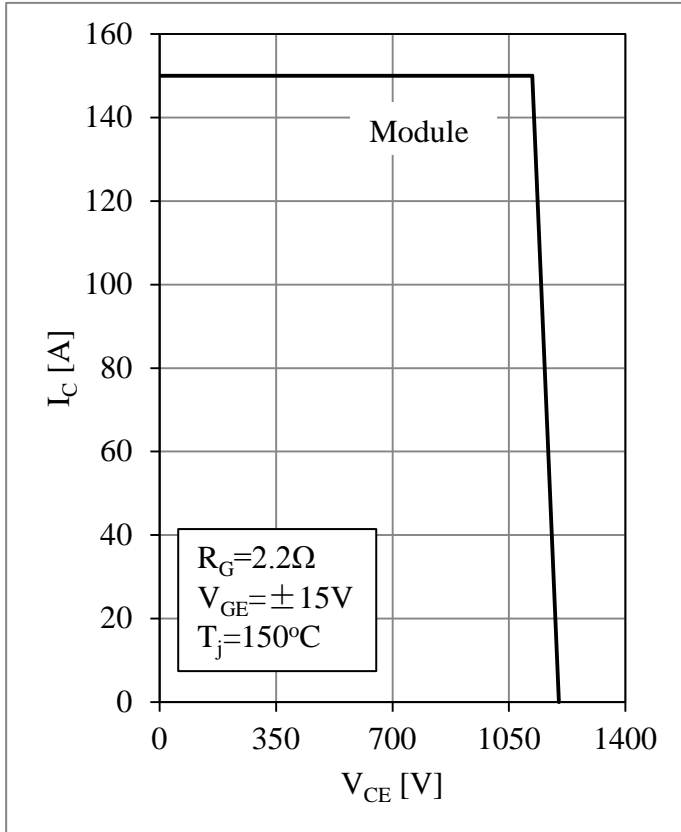

Fig 5. RBSOA

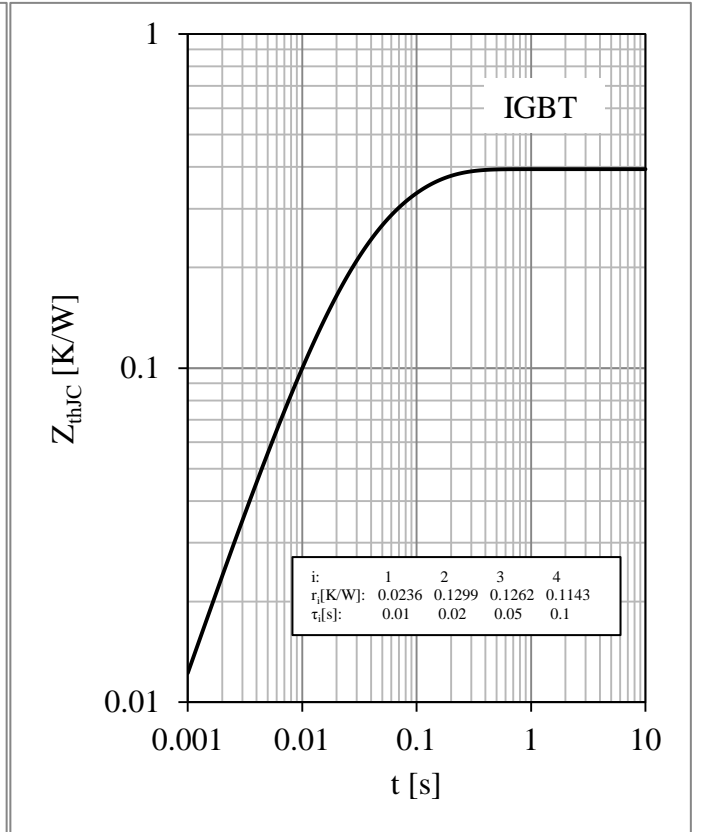

Fig 6. IGBT Transient Thermal Impedance

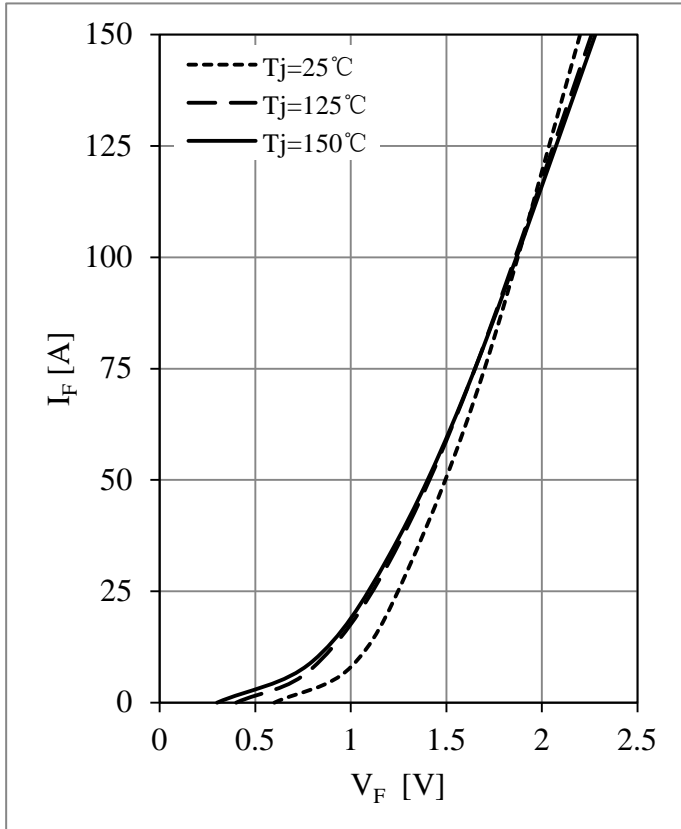

Fig 7. Diode Forward Characteristics

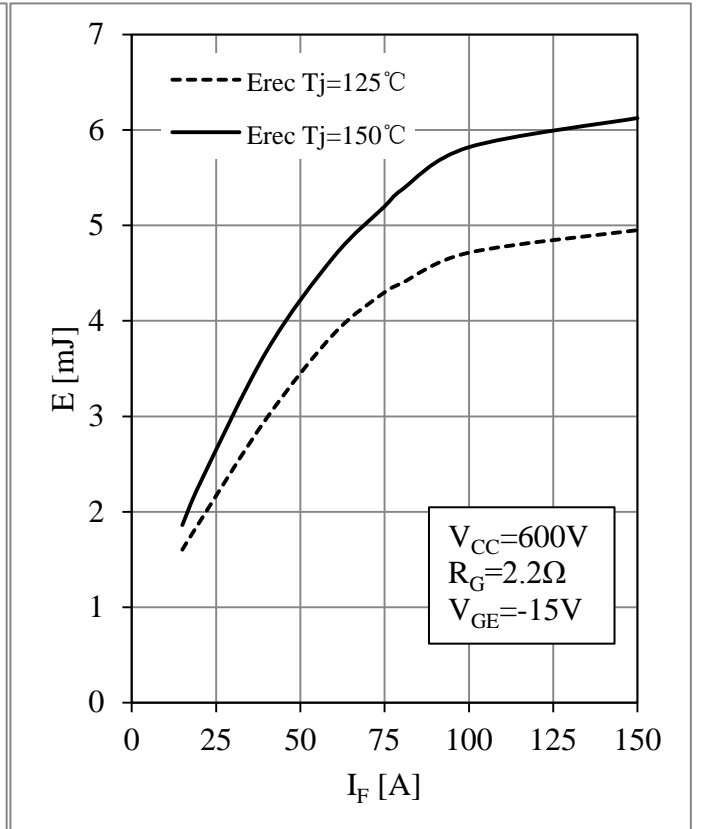

Fig 8. Diode Switching Loss vs. I<sub>F</sub>

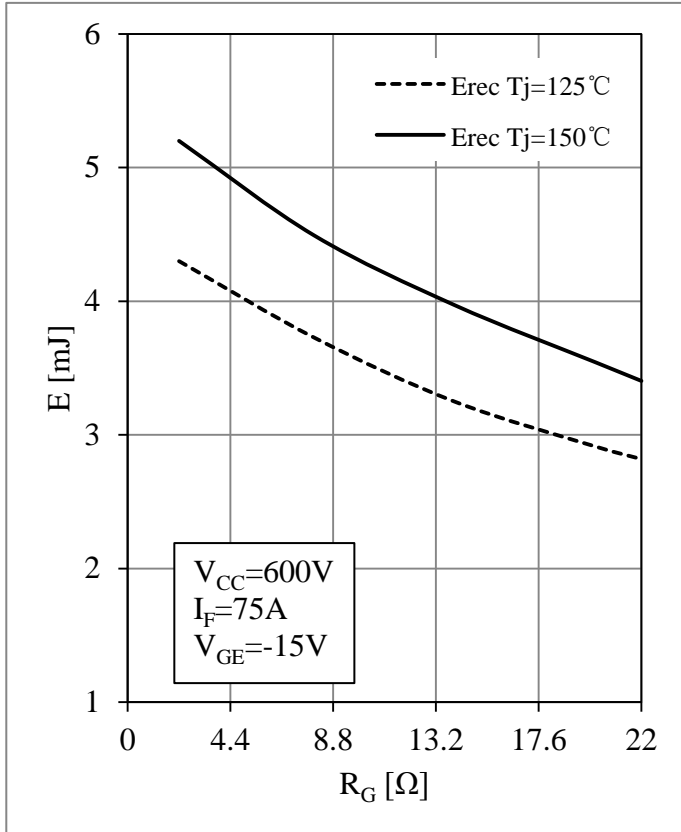

Fig 9. Diode Switching Loss vs.  $R_G$

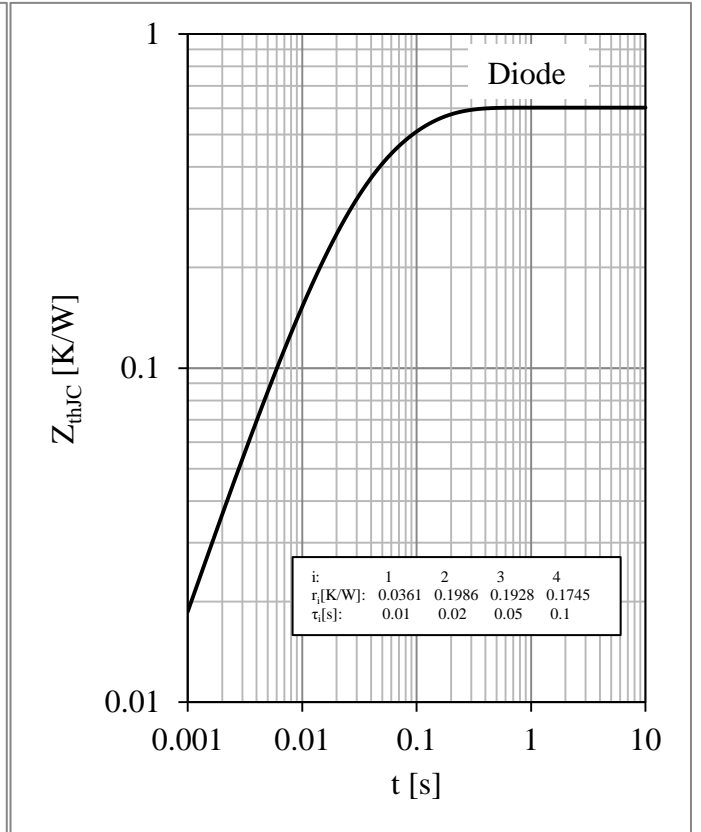
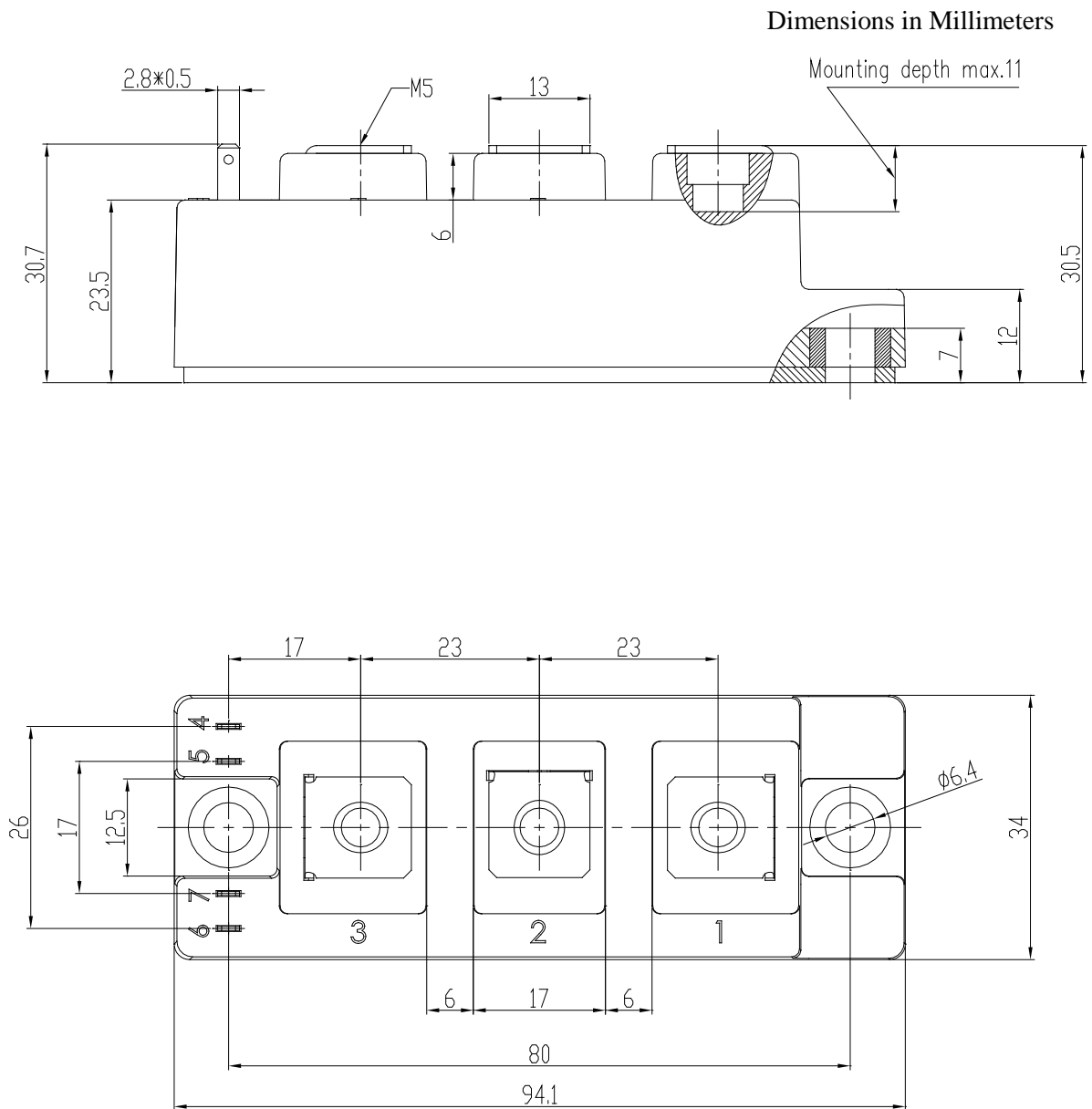

Fig 10. Diode Transient Thermal Impedance

### Circuit Schematic



### Package Dimensions





## Terms and Conditions of Usage

The data contained in this product datasheet is exclusively intended for technically trained staff. you and your technical departments will have to evaluate the suitability of the product for the intended application and the completeness of the product data with respect to such application.

This product data sheet is describing the characteristics of this product for which a warranty is granted. Any such warranty is granted exclusively pursuant the terms and conditions of the supply agreement. There will be no guarantee of any kind for the product and its characteristics.

Should you require product information in excess of the data given in this product data sheet or which concerns the specific application of our product, please contact the sales office, which is responsible for you (see [www.powersemi.cc](http://www.powersemi.cc)), For those that are specifically interested we may provide application notes.

Due to technical requirements our product may contain dangerous substances. For information on the types in question please contact the sales office, which is responsible for you.

Should you intend to use the Product in aviation applications, in health or live endangering or life support applications, please notify.

If and to the extent necessary, please forward equivalent notices to your customers.  
Changes of this product data sheet are reserved.