

# STARPOWER

SEMICONDUCTOR

# IGBT

## GD75PIL120C6S

**1200V/75A PIM in one-package**

### General Description

STARPOWER IGBT Power Module provides ultra low conduction loss as well as short circuit ruggedness. They are designed for the applications such as general inverters and UPS.

### Features

- Low  $V_{CE(sat)}$  SPT+ IGBT technology
- 10 $\mu$ s short circuit capability
- $V_{CE(sat)}$  with positive temperature coefficient
- Maximum junction temperature 175 °C
- Low inductance case
- Fast & soft reverse recovery anti-parallel FWD
- Isolated copper baseplate using DBC technology



### Typical Applications

- Inverter for motor drive
- AC and DC servo drive amplifier
- Uninterruptible power supply

### Equivalent Circuit Schematic

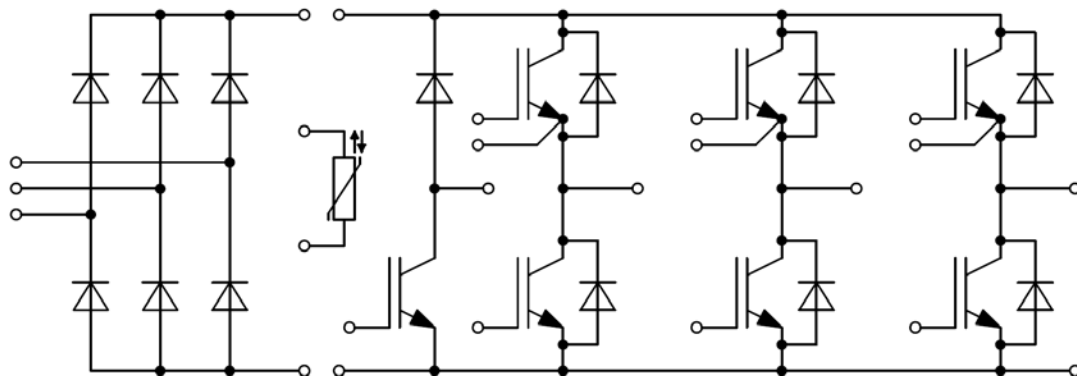

**Absolute Maximum Ratings**  $T_C=25^{\circ}\text{C}$  unless otherwise noted**IGBT-inverter**

Symbol	Description	Values	Unit
$V_{CES}$	Collector-Emitter Voltage	1200	V
$V_{GES}$	Gate-Emitter Voltage	$\pm 20$	V
$I_C$	Collector Current @ $T_C=25^{\circ}\text{C}$	140	A
	@ $T_C=100^{\circ}\text{C}$	75	
$I_{CM}$	Pulsed Collector Current $t_p=1\text{ms}$	150	A
$P_D$	Maximum Power Dissipation @ $T_j=175^{\circ}\text{C}$	538	W

**Diode-inverter**

Symbol	Description	Values	Unit
$V_{RRM}$	Repetitive Peak Reverse Voltage	1200	V
$I_F$	Diode Continuous Forward Current	75	A
$I_{FM}$	Diode Maximum Forward Current $t_p=1\text{ms}$	150	A

**Diode-rectifier**

Symbol	Description	Values	Unit
$V_{RRM}$	Repetitive Peak Reverse Voltage	1600	V
$I_O$	Average Output Current @ $T_C=80^{\circ}\text{C}$	75	A
$I_{FSM}$	Surge Forward Current $V_R=0\text{V}, t_p=10\text{ms}, T_j=45^{\circ}\text{C}$	1100	A
$I^2t$	$I^2t$ -value, $V_R=0\text{V}, t_p=10\text{ms}, T_j=45^{\circ}\text{C}$	6050	$\text{A}^2\text{s}$

**IGBT-brake**

Symbol	Description	Values	Unit
$V_{CES}$	Collector-Emitter Voltage	1200	V
$V_{GES}$	Gate-Emitter Voltage	$\pm 30$	V
$I_C$	Collector Current @ $T_C=25^{\circ}\text{C}$	80	A
	@ $T_C=100^{\circ}\text{C}$	40	
$I_{CM}$	Pulsed Collector Current $t_p=1\text{ms}$	80	A
$P_D$	Maximum Power Dissipation @ $T_j=175^{\circ}\text{C}$	337	W

**Diode-brake**

Symbol	Description	Values	Unit
$V_{RRM}$	Repetitive Peak Reverse Voltage	1200	V
$I_F$	Diode Continuous Forward Current	40	A
$I_{FM}$	Diode Maximum Forward Current $t_p=1\text{ms}$	80	A

**Module**

Symbol	Description	Values	Unit
$T_{jmax}$	Maximum Junction Temperature(inverter,brake)	175	$^{\circ}\text{C}$
	Maximum Junction Temperature (rectifier)	150	
$T_{jop}$	Operating Junction Temperature	-40 to +150	$^{\circ}\text{C}$
$T_{STG}$	Storage Temperature Range	-40 to +125	$^{\circ}\text{C}$
$V_{ISO}$	Isolation Voltage RMS, $f=50\text{Hz}, t=1\text{min}$	4000	V
M	Mounting Torque, Screw M5	3.0 to 6.0	N.m

**IGBT-inverter Characteristics**  $T_C=25^\circ\text{C}$  unless otherwise noted

Symbol	Parameter	Test Conditions	Min.	Typ.	Max.	Unit
$V_{CE(sat)}$	Collector to Emitter Saturation Voltage	$I_C=75\text{A}, V_{GE}=15\text{V}, T_j=25^\circ\text{C}$		1.90	2.35	V
		$I_C=75\text{A}, V_{GE}=15\text{V}, T_j=125^\circ\text{C}$		2.10		
		$I_C=75\text{A}, V_{GE}=15\text{V}, T_j=150^\circ\text{C}$		2.20		
$V_{GE(th)}$	Gate-Emitter Threshold Voltage	$I_C=3.0\text{mA}, V_{CE}=V_{GE}, T_j=25^\circ\text{C}$	5.0	6.5	7.0	V
$I_{CES}$	Collector Cut-Off Current	$V_{CE}=V_{CES}, V_{GE}=0\text{V}, T_j=25^\circ\text{C}$			1.0	mA
$I_{GES}$	Gate-Emitter Leakage Current	$V_{GE}=V_{GES}, V_{CE}=0\text{V}, T_j=25^\circ\text{C}$			400	nA
$R_{Gint}$	Internal Gate Resistance			3.0		$\Omega$
$C_{ies}$	Input Capacitance	$V_{CE}=25\text{V}, f=1\text{MHz}, V_{GE}=0\text{V}$		5.52		nF
$C_{res}$	Reverse Transfer Capacitance				0.26	
$Q_G$	Gate Charge	$V_{GE}=-15 \dots +15\text{V}$		0.78		$\mu\text{C}$
$t_{d(on)}$	Turn-On Delay Time	$V_{CC}=600\text{V}, I_C=75\text{A}, R_G=1.0\Omega, V_{GE}=\pm 15\text{V}, T_j=25^\circ\text{C}$		519		ns
$t_r$	Rise Time			103		ns
$t_{d(off)}$	Turn-Off Delay Time			492		ns
$t_f$	Fall Time			215		ns
$E_{on}$	Turn-On Switching Loss			9.76		mJ
$E_{off}$	Turn-Off Switching Loss			5.03		mJ
$t_{d(on)}$	Turn-On Delay Time	$V_{CC}=600\text{V}, I_C=75\text{A}, R_G=1.0\Omega, V_{GE}=\pm 15\text{V}, T_j=125^\circ\text{C}$		519		ns
$t_r$	Rise Time			104		ns
$t_{d(off)}$	Turn-Off Delay Time			517		ns
$t_f$	Fall Time			344		ns
$E_{on}$	Turn-On Switching Loss			11.9		mJ
$E_{off}$	Turn-Off Switching Loss			7.01		mJ
$t_{d(on)}$	Turn-On Delay Time	$V_{CC}=600\text{V}, I_C=75\text{A}, R_G=1.0\Omega, V_{GE}=\pm 15\text{V}, T_j=150^\circ\text{C}$		527		ns
$t_r$	Rise Time			105		ns
$t_{d(off)}$	Turn-Off Delay Time			527		ns
$t_f$	Fall Time			395		ns
$E_{on}$	Turn-On Switching Loss			13.5		mJ
$E_{off}$	Turn-Off Switching Loss			8.30		mJ
$I_{SC}$	SC Data	$t_p \leq 10\mu\text{s}, V_{GE}=15\text{V}, T_j=150^\circ\text{C}, V_{CC}=900\text{V}, V_{CEM} \leq 1200\text{V}$		350		A

**Diode-inverter Characteristics**  $T_C=25^\circ\text{C}$  unless otherwise noted

Symbol	Parameter	Test Conditions	Min.	Typ.	Max.	Units
$V_F$	Diode Forward Voltage	$I_C=75\text{A}, V_{GE}=0\text{V}, T_j=25^\circ\text{C}$		1.80	2.25	V
		$I_C=75\text{A}, V_{GE}=0\text{V}, T_j=125^\circ\text{C}$		1.85		
		$I_C=75\text{A}, V_{GE}=0\text{V}, T_j=150^\circ\text{C}$		1.85		
$Q_r$	Recovered Charge			3.7		$\mu\text{C}$
$I_{RM}$	Peak Reverse Recovery Current	$V_R=600\text{V}, I_F=75\text{A}, R_G=1.0\Omega, V_{GE}=-15\text{V}$		42		A
$E_{rec}$	Reverse Recovery Energy	$T_j=25^\circ\text{C}$		2.24		mJ
$Q_r$	Recovered Charge			13.6		$\mu\text{C}$
$I_{RM}$	Peak Reverse Recovery Current	$V_R=600\text{V}, I_F=75\text{A}, R_G=1.0\Omega, V_{GE}=-15\text{V}$		64		A
$E_{rec}$	Reverse Recovery Energy	$T_j=125^\circ\text{C}$		5.30		mJ
$Q_r$	Recovered Charge			15.9		$\mu\text{C}$
$I_{RM}$	Peak Reverse Recovery Current	$V_R=600\text{V}, I_F=75\text{A}, R_G=1.0\Omega, V_{GE}=-15\text{V}$		69		A
$E_{rec}$	Reverse Recovery Energy	$T_j=150^\circ\text{C}$		6.36		mJ

**Diode-rectifier Characteristics**  $T_C=25^\circ\text{C}$  unless otherwise noted

Symbol	Parameter	Test Conditions	Min.	Typ.	Max.	Units
$V_F$	Diode Forward Voltage	$I_C=75\text{A}, T_j=150^\circ\text{C}$		1.08		V
$I_R$	Reverse Current	$T_j=150^\circ\text{C}, V_R=1600\text{V}$			2.0	mA

**IGBT-brake Characteristics**  $T_C=25^\circ\text{C}$  unless otherwise noted

Symbol	Parameter	Test Conditions	Min.	Typ.	Max.	Unit
$V_{CE(sat)}$	Collector to Emitter Saturation Voltage	$I_C=40\text{A}, V_{GE}=15\text{V}, T_j=25^\circ\text{C}$		1.80	2.25	V
		$I_C=40\text{A}, V_{GE}=15\text{V}, T_j=125^\circ\text{C}$		2.00		
		$I_C=40\text{A}, V_{GE}=15\text{V}, T_j=150^\circ\text{C}$		2.05		
$V_{GE(th)}$	Gate-Emitter Threshold Voltage	$I_C=2.4\text{mA}, V_{CE}=V_{GE}, T_j=25^\circ\text{C}$	5.0	6.1	7.5	V
$I_{CES}$	Collector Cut-Off Current	$V_{CE}=V_{CES}, V_{GE}=0\text{V}, T_j=25^\circ\text{C}$			1.0	mA
$I_{GES}$	Gate-Emitter Leakage Current	$V_{GE}=V_{GES}, V_{CE}=0\text{V}, T_j=25^\circ\text{C}$			400	nA
$R_{Gint}$	Internal Gate Resistance			/		$\Omega$
$C_{ies}$	Input Capacitance	$V_{CE}=30\text{V}, f=1\text{MHz}, V_{GE}=0\text{V}$		6.24		nF
$C_{res}$	Reverse Transfer Capacitance			0.15		nF
$Q_G$	Gate Charge	$V_{GE}=15\text{V}$		0.23		$\mu\text{C}$
$t_{d(on)}$	Turn-On Delay Time	$V_{CC}=600\text{V}, I_C=40\text{A}, R_G=24\Omega, V_{GE}=\pm 15\text{V}, T_j=25^\circ\text{C}$		370		ns
$t_r$	Rise Time			84		ns
$t_{d(off)}$	Turn-Off Delay Time			334		ns
$t_f$	Fall Time			276		ns
$E_{on}$	Turn-On Switching Loss			5.45		mJ
$E_{off}$	Turn-Off Switching Loss			2.21		mJ
$t_{d(on)}$	Turn-On Delay Time	$V_{CC}=600\text{V}, I_C=40\text{A}, R_G=24\Omega, V_{GE}=\pm 15\text{V}, T_j=125^\circ\text{C}$		375		ns
$t_r$	Rise Time			87		ns
$t_{d(off)}$	Turn-Off Delay Time			350		ns
$t_f$	Fall Time			328		ns
$E_{on}$	Turn-On Switching Loss			6.05		mJ
$E_{off}$	Turn-Off Switching Loss			3.45		mJ
$t_{d(on)}$	Turn-On Delay Time	$V_{CC}=600\text{V}, I_C=40\text{A}, R_G=24\Omega, V_{GE}=\pm 15\text{V}, T_j=150^\circ\text{C}$		376		ns
$t_r$	Rise Time			92		ns
$t_{d(off)}$	Turn-Off Delay Time			350		ns
$t_f$	Fall Time			338		ns
$E_{on}$	Turn-On Switching Loss			6.30		mJ
$E_{off}$	Turn-Off Switching Loss			3.70		mJ
$I_{SC}$	SC Data	$t_p \leq 10\mu\text{s}, V_{GE}=15\text{V}, T_j=150^\circ\text{C}, V_{CC}=900\text{V}, V_{CEM} \leq 1200\text{V}$		500		A

**Diode-brake Characteristics**  $T_C=25^\circ\text{C}$  unless otherwise noted

Symbol	Parameter	Test Conditions	Min.	Typ.	Max.	Units
$V_F$	Diode Forward Voltage	$I_C=40\text{A}, V_{GE}=0\text{V}, T_j=25^\circ\text{C}$		2.10	2.55	V
		$I_C=40\text{A}, V_{GE}=0\text{V}, T_j=125^\circ\text{C}$		2.00		
		$I_C=40\text{A}, V_{GE}=0\text{V}, T_j=150^\circ\text{C}$		1.97		
$Q_r$	Recovered Charge			2.5		$\mu\text{C}$
$I_{RM}$	Peak Reverse Recovery Current	$V_R=600\text{V}, I_F=40\text{A}, R_G=24\Omega, V_{GE}=-15\text{V}$		22		A
$E_{rec}$	Reverse Recovery Energy	$T_j=25^\circ\text{C}$		1.28		mJ
$Q_r$	Recovered Charge			4.8		$\mu\text{C}$
$I_{RM}$	Peak Reverse Recovery Current	$V_R=600\text{V}, I_F=40\text{A}, R_G=24\Omega, V_{GE}=-15\text{V}$		26		A
$E_{rec}$	Reverse Recovery Energy	$T_j=125^\circ\text{C}$		2.40		mJ
$Q_r$	Recovered Charge			5.0		$\mu\text{C}$
$I_{RM}$	Peak Reverse Recovery Current	$V_R=600\text{V}, I_F=40\text{A}, R_G=24\Omega, V_{GE}=-15\text{V}$		28		A
$E_{rec}$	Reverse Recovery Energy	$T_j=150^\circ\text{C}$		2.50		mJ

**NTC Characteristics**  $T_C=25^\circ\text{C}$  unless otherwise noted

Symbol	Parameter	Test Conditions	Min.	Typ.	Max.	Units
$R_{25}$	Rated Resistance			5.0		$\text{k}\Omega$
$\Delta R/R$	Deviation of $R_{100}$	$T_C=100^\circ\text{C}, R_{100}=493.3\Omega$	-5		5	%
$P_{25}$	Power Dissipation				20.0	mW
$B_{25/50}$	B-value	$R_2=R_{25}\exp[B_{25/50}(1/T_2-1/(298.15\text{K}))]$		3375		K

**Module Characteristics**  $T_C=25^\circ\text{C}$  unless otherwise noted

Symbol	Parameter	Min.	Typ.	Max.	Unit
$L_{CE}$	Stray Inductance		60		nH
$R_{CC'+EE'}$	Module Lead Resistance, Terminal to Chip @ $T_C=25^\circ\text{C}$		4.00 2.00		$\text{m}\Omega$
$R_{\theta JC}$	Junction-to-Case (per IGBT-inverter)			0.279	K/W
	Junction-to-Case (per Diode-inverter)			0.494	
	Junction-to-Case (per Diode-rectifier)			0.548	
	Junction-to-Case (per IGBT-brake-chopper)			0.445	
	Junction-to-Case (per Diode-brake-chopper)			0.967	
$R_{\theta CS}$	Case-to-Sink (per IGBT-inverter)		0.120		K/W
	Case-to-Sink (per Diode-inverter)		0.213		
	Case-to-Sink (per Diode-rectifier)		0.236		
	Case-to-Sink (per IGBT-brake-chopper)		0.192		
	Case-to-Sink (per Diode-brake-chopper)		0.417		
$R_{\theta CS}$	Case-to-Sink		0.009		K/W
G	Weight of Module		300		g

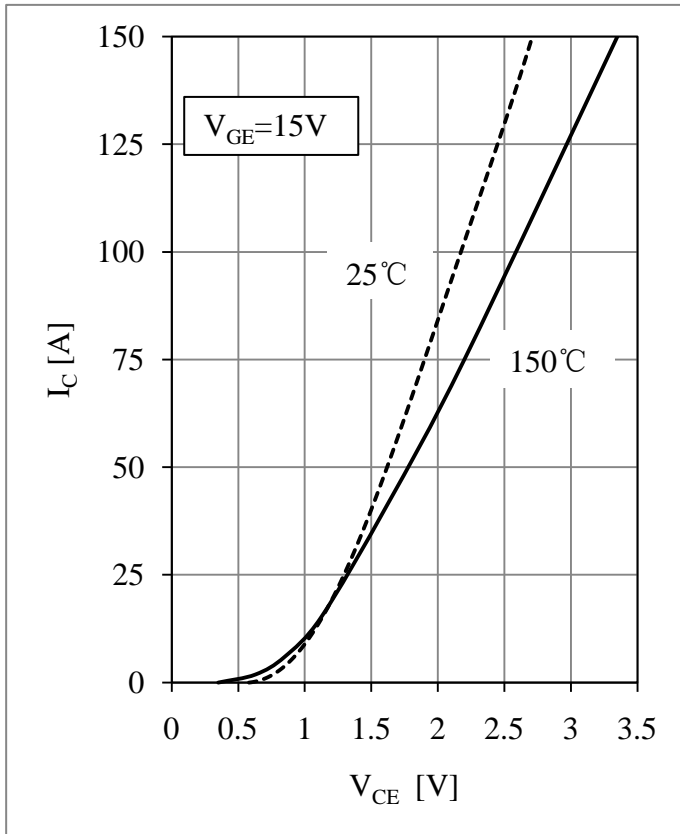

Fig 1. IGBT-inverter Output Characteristics

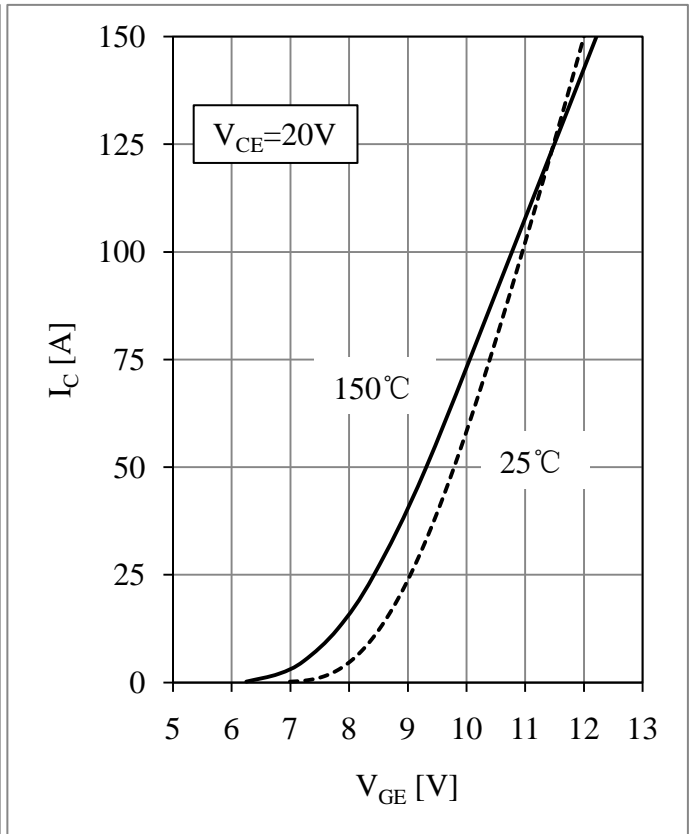

Fig 2. IGBT-inverter Transfer Characteristics

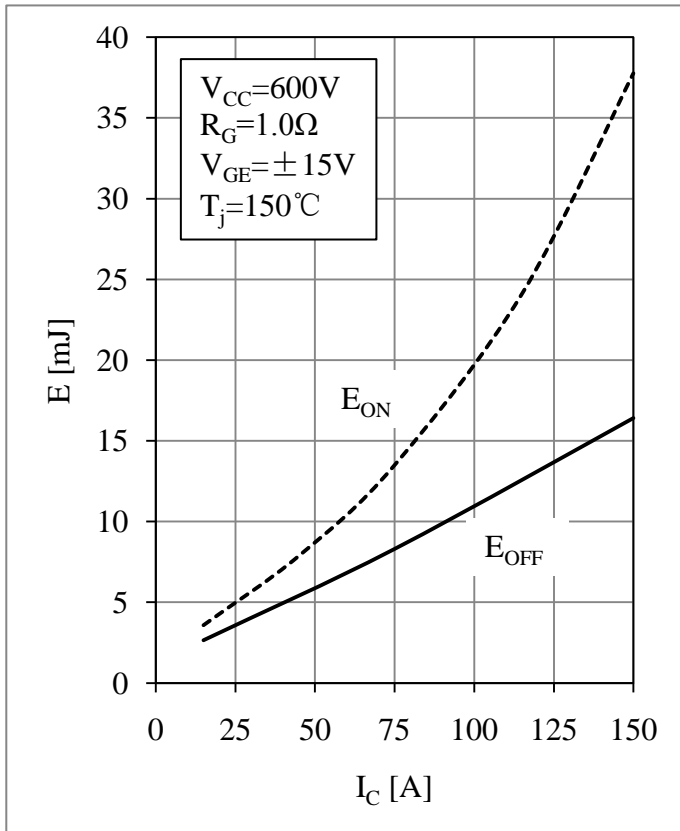

Fig 3. IGBT-inverter Switching Loss vs.  $I_C$

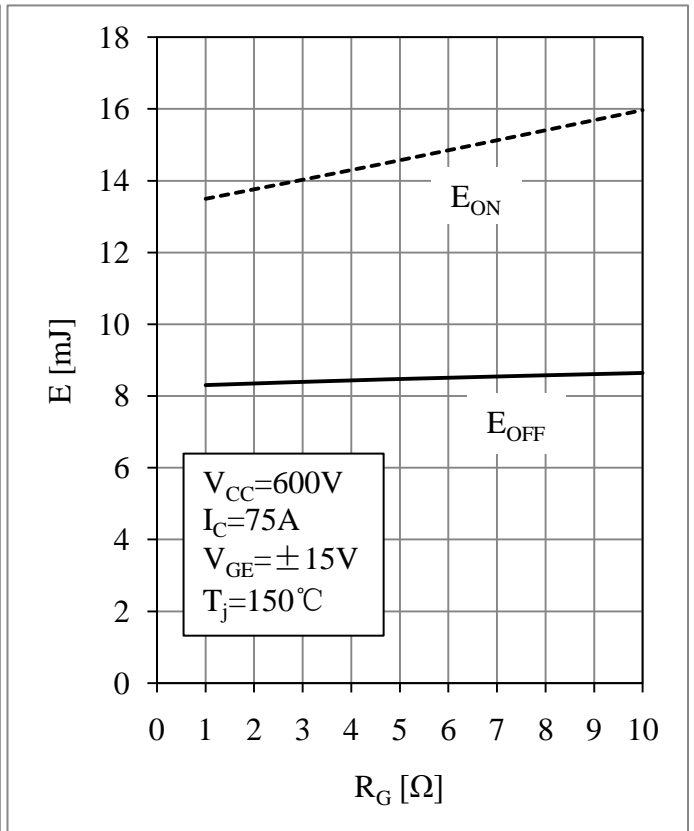

Fig 4. IGBT-inverter Switching Loss vs.  $R_G$

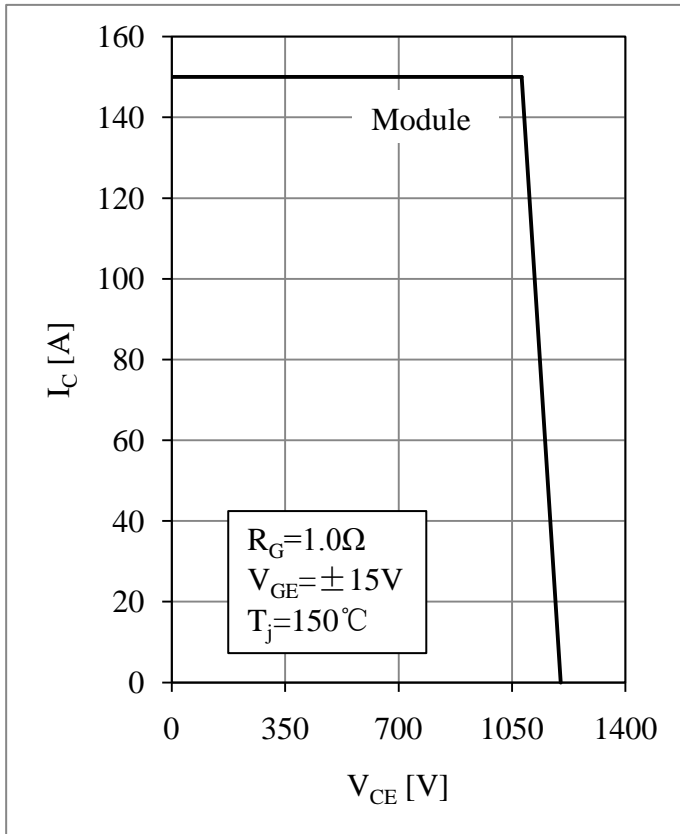

Fig 5. IGBT-inverter RBSOA

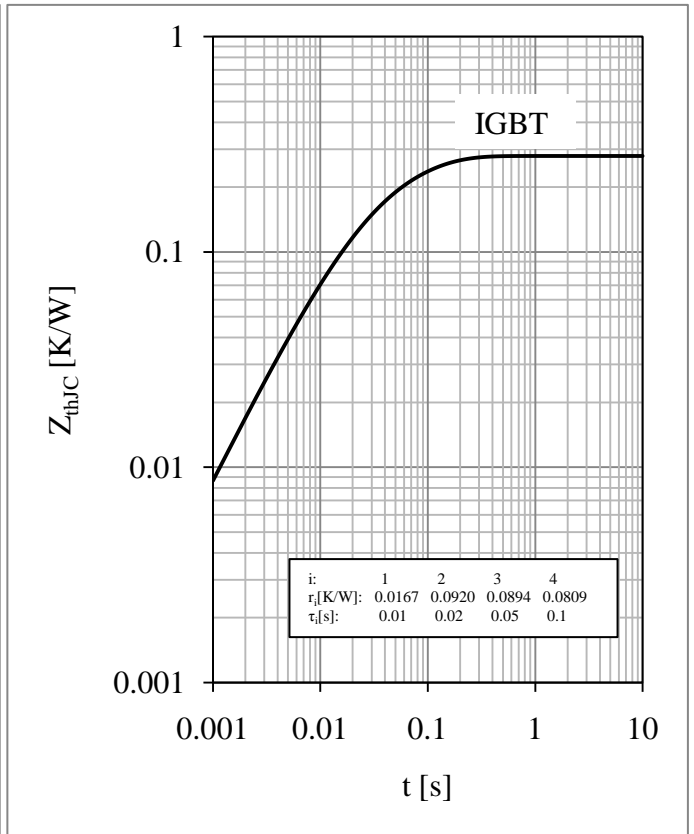

Fig 6. IGBT-inverter Transient Thermal Impedance

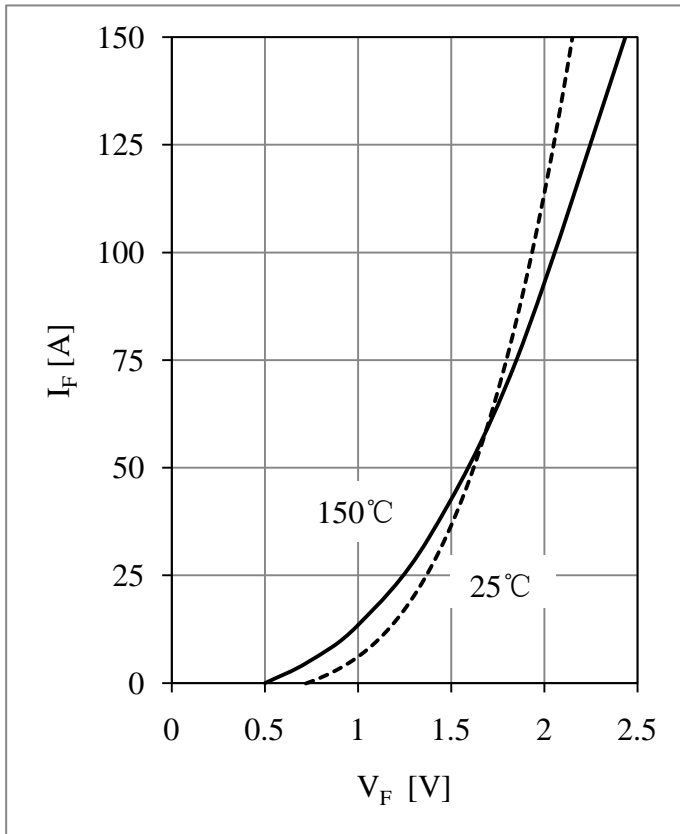

Fig 7. Diode-inverter Forward Characteristics

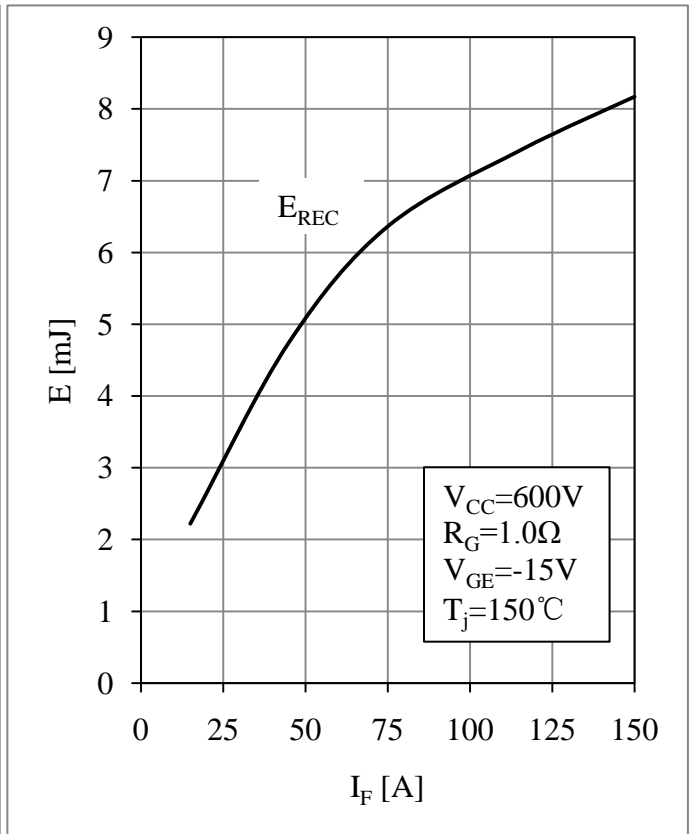

Fig 8. Diode-inverter Switching Loss vs.  $I_F$



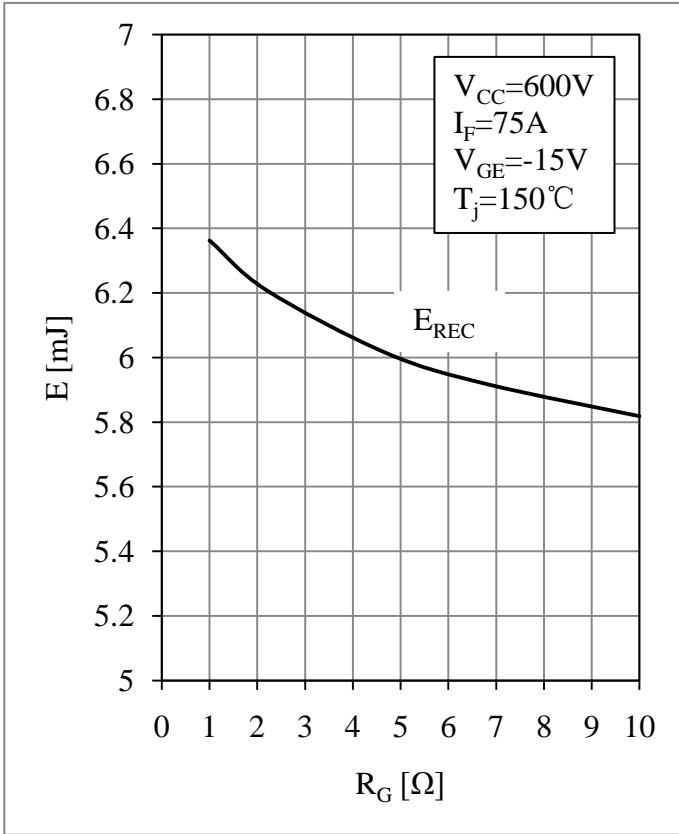

Fig 9. Diode-inverter Switching Loss vs.  $R_G$

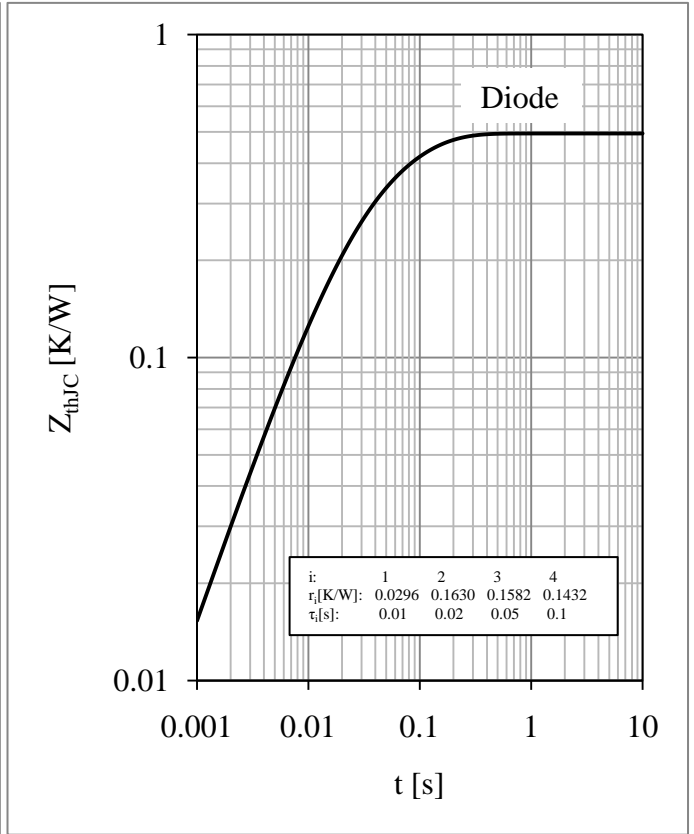

Fig 10. Diode-inverter Transient Thermal Impedance

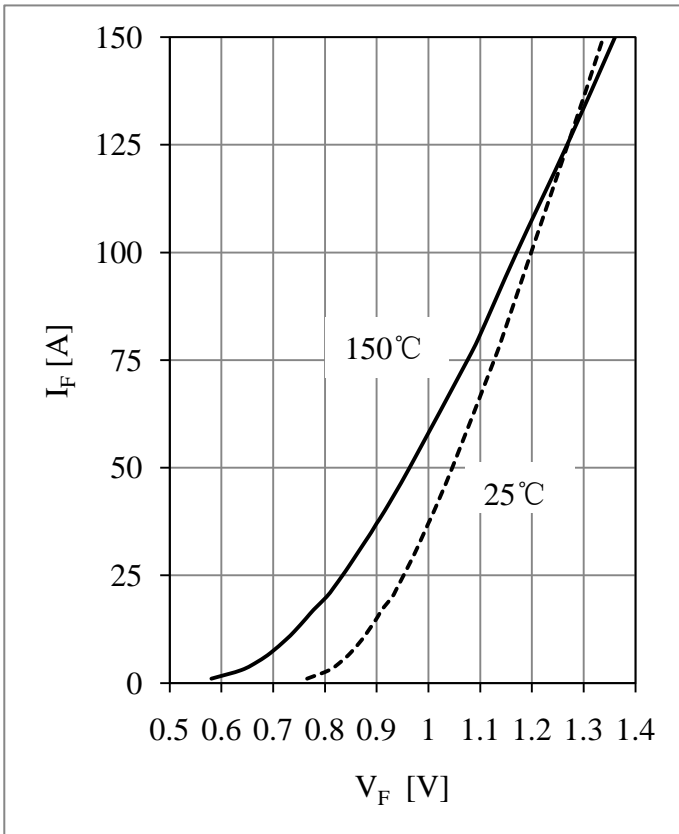

Fig 11. Diode-rectifier Forward Characteristics

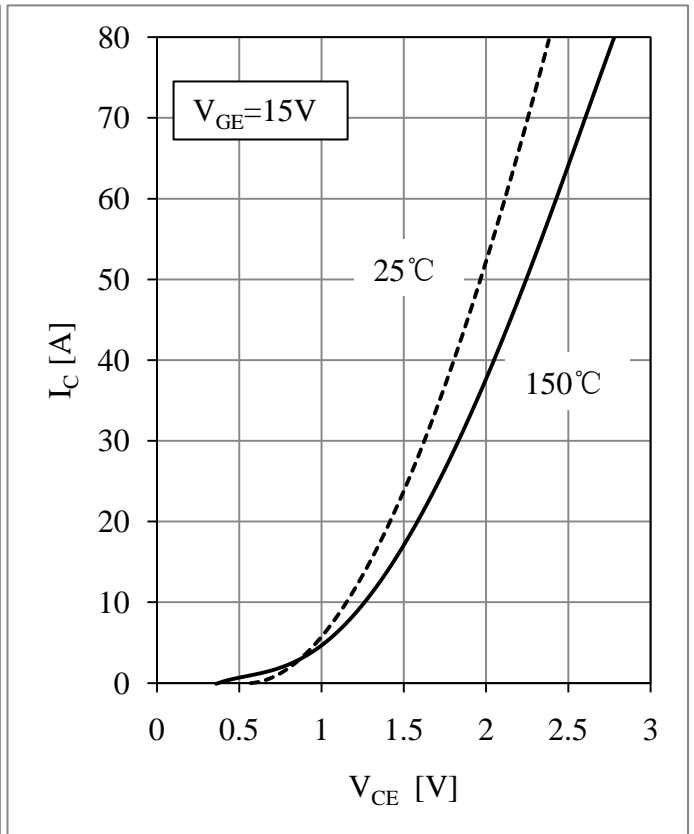

Fig 12. IGBT-brake-chopper Output Characteristics

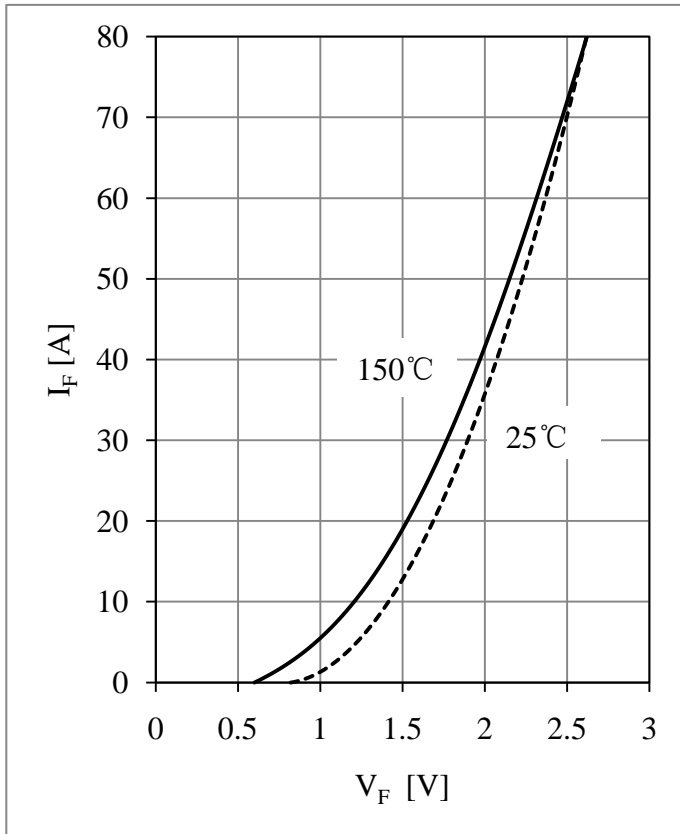

Fig 13. Diode-brake-chopper Forward Characteristics

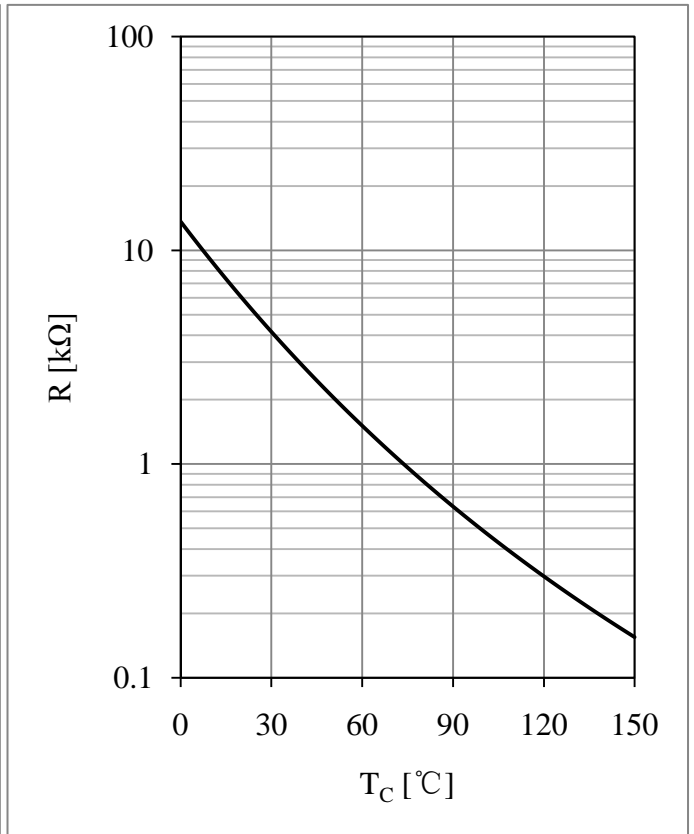
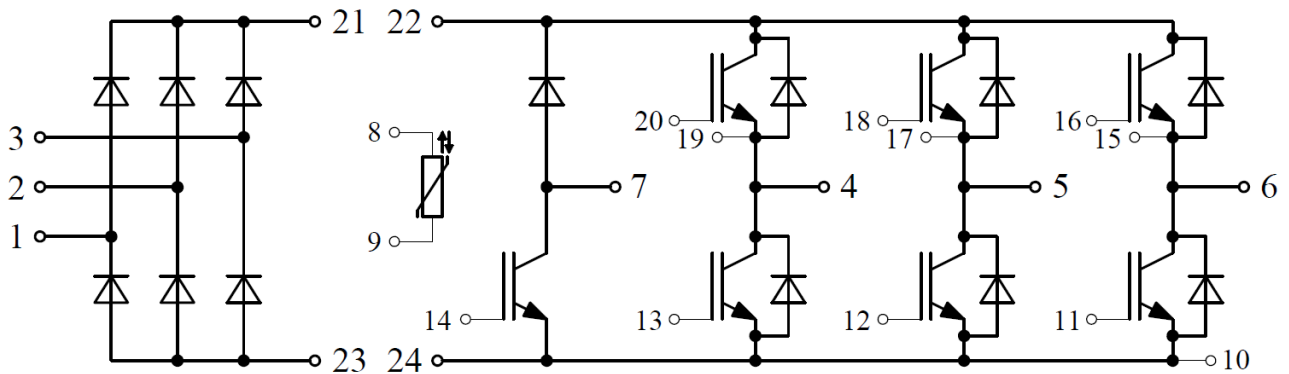

Fig 14. NTC Temperature Characteristic

**Circuit Schematic**



**Package Dimensions**

Dimensions in Millimeters

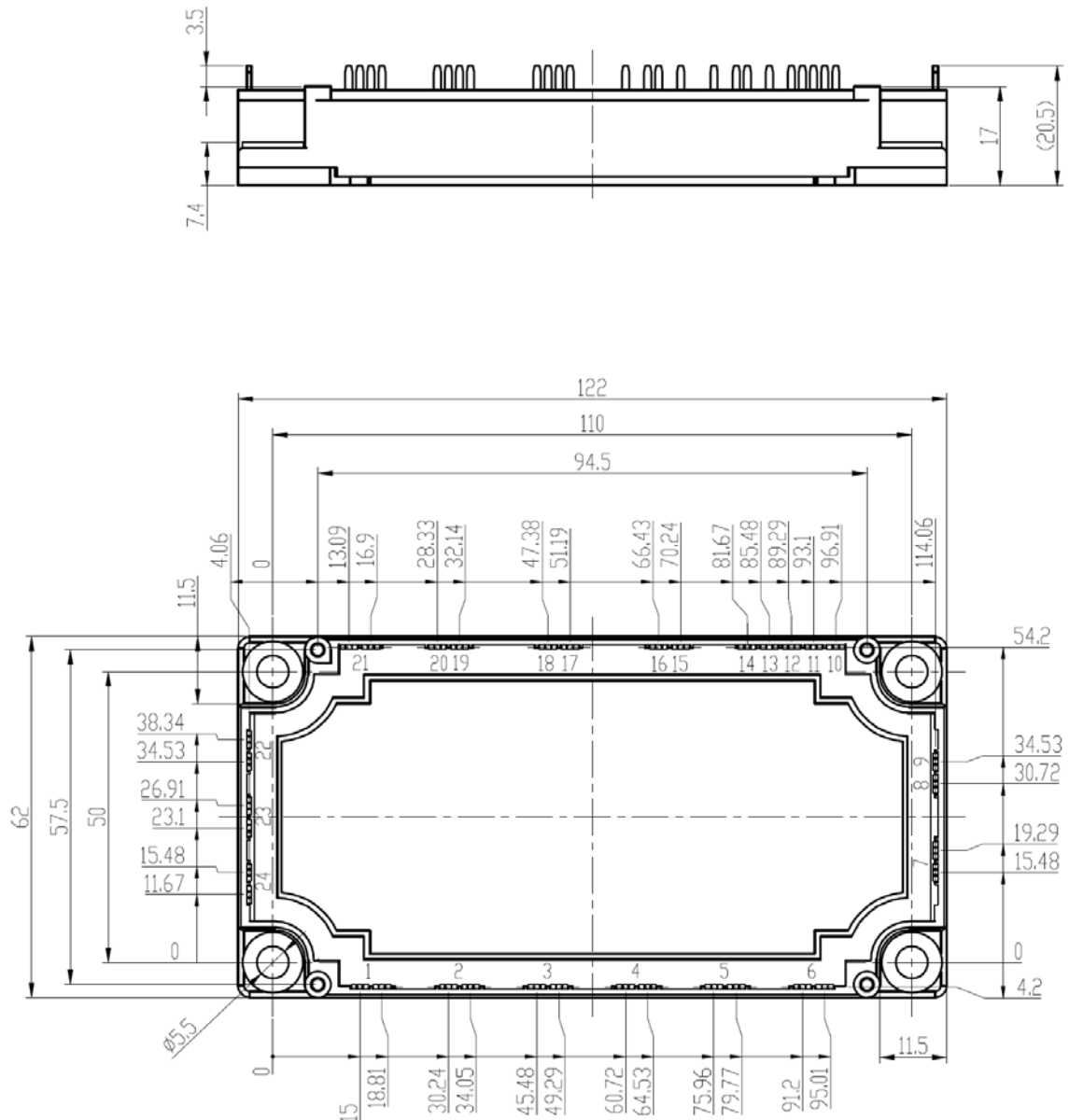

## Terms and Conditions of Usage

The data contained in this product datasheet is exclusively intended for technically trained staff. you and your technical departments will have to evaluate the suitability of the product for the intended application and the completeness of the product data with respect to such application.

This product data sheet is describing the characteristics of this product for which a warranty is granted. Any such warranty is granted exclusively pursuant the terms and conditions of the supply agreement. There will be no guarantee of any kind for the product and its characteristics.

Should you require product information in excess of the data given in this product data sheet or which concerns the specific application of our product, please contact the sales office, which is responsible for you (see [www.powersemi.cc](http://www.powersemi.cc)), For those that are specifically interested we may provide application notes.

Due to technical requirements our product may contain dangerous substances. For information on the types in question please contact the sales office, which is responsible for you.

Should you intend to use the Product in aviation applications, in health or live endangering or life support applications, please notify.

If and to the extent necessary, please forward equivalent notices to your customers.  
Changes of this product data sheet are reserved.